

SEO best practice guide for PR

Published May 2021

vuelio

Access Intelligence Plc

The Johnson Building,
79 Hatton Garden
London
EC1N 8AW

Tel: +44 (0) 203 426 4070

Email: info@vuelio.com **Website:** <http://www.vuelio.com/uk>

Contents

1.	Introduction	4
1.1	About the author	5
1.2	About Vuelio	5
2.	SEO basics	7
2.1	What is traditionally meant by SEO	7
2.2	Search rankings	8
2.3	Search visibility	9
2.4	Searchers needs revealed in search terms	10
3.	How Google Works	12
3.1	Spiders	12
3.2	Database/Index	13
3.3	Algorithms	13
3.4	E-A-T Ratings of Content	13
3.4.1	Expertise of the author	14
3.4.2	Is the web page Authoritative?	14
3.4.3	Is the website Trustworthy?	16
4.	How to Build a PR SEO Strategy	17
4.1	Understand the signals Google looks for	17
4.2	Technical web elements you need to know	17
4.3	Planning out the overlap to create a SEO PR strategy	18
4.3.1	Competitor Keyword Analysis	19
4.3.2	Competitor backlink analysis	19
4.3.3	Find and fix keyword cannibalisation	21
5.	Keywords, Content, and On-Page Essentials	23
5.1	Understanding keywords from Google's point of view	23
5.2	Keyword research and different ways to do it	24
5.3	Content creation – its purpose and how Google specifically sees it	28

5.4	Optimising content specifically for the web	29
6.	Advanced On-Page SEO	32
6.1	Image alt attributes	32
6.2	Schema	33
6.3	FAQ Schema	33
6.4	Internal linking	34
6.5	6.5 Jump-to links for sitelinks	35
6.6	Featured Snippet tricks	37
7.	Link Building for PRs	39
7.1	Introduction	39
7.2	Which sites provide valuable links?	39
7.3	What is a link worth?	40
7.4	What is a 'good link'?	41
7.5	Digital PR vs Link Building	42
7.6	What it takes to get links	42
7.7	What writers cover and why they link	44
7.8	Unlinked mentions	46
7.9	Social media and links	47
7.10	Chasing competitor links	48
7.11	Outreach	48
7.12	Planning Outreach – Topic Identification	49
7.13	Doing Outreach	52
7.14	Ideas for passive link building	52
8.	Benchmarking and Measuring SEO Success	55
9.	SEO and ethics	58
9.1	What is 'Black Hat' SEO?	58
10.	Reading, Resources, and Continued Education	60

Introduction

Today's PR and Communications professionals are operating in an increasingly fragmented digital environment.

The modern PR practitioner requires much more than a basic understanding of search, yet there are very few resources written specifically for the sector.

As more agencies, businesses and organisations develop digital-led PR strategies, many PR and comms practitioners understand the impact and value of generating coverage in online media *and* generating links.

Optimising content such as reports, white papers, videos, and blog posts for visibility in search can increase brand awareness.

Increasing visibility, perceived expertise, and topical alignment through search visibility also helps build reputation and can impact lead generation, sales and other forms of valuable 'conversion' – for example, a donation to a charity or download of specific health advice.

Search visibility is important, and is an important part of any multichannel marketing strategy. For example, 49% of users saying that they use Google to discover or find a new item or product and 59% of shoppers say that they use Google to research a purchase they plan to make in-store or online.¹

As a leading provider of tools and services for multichannel PR, communications and marketing professionals we've designed this guide to cover one of the core skills and topics of importance in a modern PR and Communications role.

It includes an SEO overview, guidance, up-to-date and advanced SEO insights from one of the worlds' leading experts.

The 'The PR Practitioner's Guide to SEO' covers:

- **What is SEO?** – information about search engine rankings, what visibility means in digital PR, and the concept of search 'demand'
- **How Google Works** – the technical side of search engines, covering spiders, the index, and how Google sees expertise, authority, and trust
- **How to Build a PR SEO Strategy** – the signals search engines look for, the technical bits you need to understand and the important elements for success
- **Keywords, Content, and On-Page Essentials** – delves more deeply into the kind of research currently possible to understand search demand, how to meet that demand and do it in a way rewarded by search engines
- **Advanced SEO** – a deeper look at advanced elements search engines look for which could help the content you are creating stand out in search engines

¹ Source: <https://www.thinkwithgoogle.com/marketing-strategies/search/google-product-discovery-statistics/>

- **Link Building for PRs and Communications Professionals** – one of the most popular topics in digital marketing and an area where digital marketers overlap with PR and Comms professionals.

This guide focuses on Google but not to the exclusion of Bing, Yandex, and others.

Only some search engines run their own engine, with 'search engines' such as Yahoo, AOL, Duck Duck Go, and others pulling the data of actual search engines into their own platforms. Optimising well for Google will ensure proper optimisation for other search engines. Google currently has around an 86% market share of searches in the UK.²

1.1 About the author

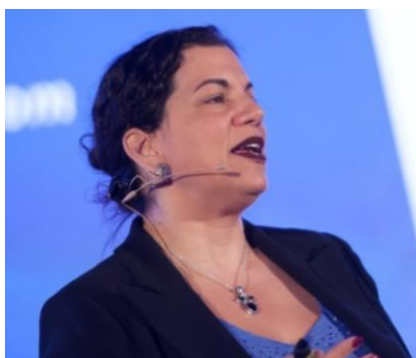

Judith Lewis is a renowned writer, trainer, blogger and a digital and media consultant specialising in applying strategic understanding of digital technologies to help businesses innovate and optimise their effectiveness within the new, networked communications environment. She rewrote the Best Practice Guide to SEO for Econsultancy, as well as contributing to the book 'Pimp My Site'.

She is a regular speaker around the world on SEO, content strategy, link building, PPC, and digital strategy, and has been recognised by her peers as one of the most influential people in the UK digital industry.

Judith judges the MENA, EU, US and UK Search Awards, an industry leading award and has every year since their inception. She has worked with market-leading global businesses.

[Find Judith](#) on [LinkedIn](#) or [Twitter @JudithLewis](#) or [@decabbit](#).

1.2 About Vuelio

In the age of information overload when it's harder than ever to cut through the noise, [Vuelio](#) helps more than 3,000 organisations around the world by providing leading PR, communications and public affairs software and expert support.

PR software

Access the world's most comprehensive media database. Get the practical information you need to make your communications even more effective with insights, distribution, monitoring and engagement plus analysis and evaluation tools.

² Source: <https://www.statista.com/statistics/220534/googles-share-of-search-market-in-selected-countries/>

Public affairs

Influence the debate with strategic insights into the political landscape. Vuelio Political Services give you the tools to identify, understand and engage with the people and policies that make a difference.

Comms Management

Build and maintain strong relationships with a CRM developed specifically for a PR, communications or public affairs team. Our software keeps track of contacts received and any response made so your team can easily monitor, measure and manage relationships.

Vuelio is part of the Access Intelligence Group that includes [ResponseSource](#), a network that connects media and influencers to the resources they need fast; and [Pulsar](#), the advanced audience intelligence and social listening platform.

SEO basics

Do a search: “how many Google searches per day”.

You’ll find the answer “Google processes over 3.5 billions searches a day”, or possibly even more.

Given the importance of search engines in our daily lives, all PR and communications professionals should have a basic understanding of how ‘the magic happens’ and what goes on when people search.

This SEO basics section explores how Google works and how SEO is broken into 3 key elements.

We touch upon machine based algorithms, human ‘Quality Raters’ and how Google weighs up web content and ranks it.

2.1 What is traditionally meant by SEO

SEO is an acronym for Search Engine Optimisation.

SEO relates to the practice of optimising a web site through ‘improving’ (for search engines specifically) on-page and off-page elements (detailed below) which it is hoped will increase the traffic the site receives from search engines.

The three major disciplines of SEO are:

Technical SEO

Traditionally, the phrase Technical SEO refers to anything that is not website content and not building links. It relates to optimising the ‘code’ of a website to ensure fast and efficient accessing (spidering) and saving (indexing) of the site by a search engine so that search engine can assess and rank it. There is more on spidering, indexing and other aspects of Technical SEO later in this guide.

On-Page SEO

On-page SEO relates to aspects of a webpage that are mostly content-based and can be tweaked or adjusted to increase that page’s visibility in search engines. These adjustments don’t usually require technical knowledge but do sometimes relate to elements not on the visible page such as the title tag, the words on the page, and the content of the page. There is a section on this later in this guide.

Off-Page SEO or Link Building

Off-page SEO relates to anything that impacts the ranking of a webpage but is not on the webpage itself, and it not technical in nature. This usually relates to links (text that when clicked, results in the browser going to a different page) but can include citations (content mentioning a brand or content but where it is not directly linked). There is a section on link building later in this guide.

This guide focuses on the non-technical elements of SEO – on and off page SEO. These are areas where PR and communications professionals can quickly make the biggest impact.

2.2 Search rankings

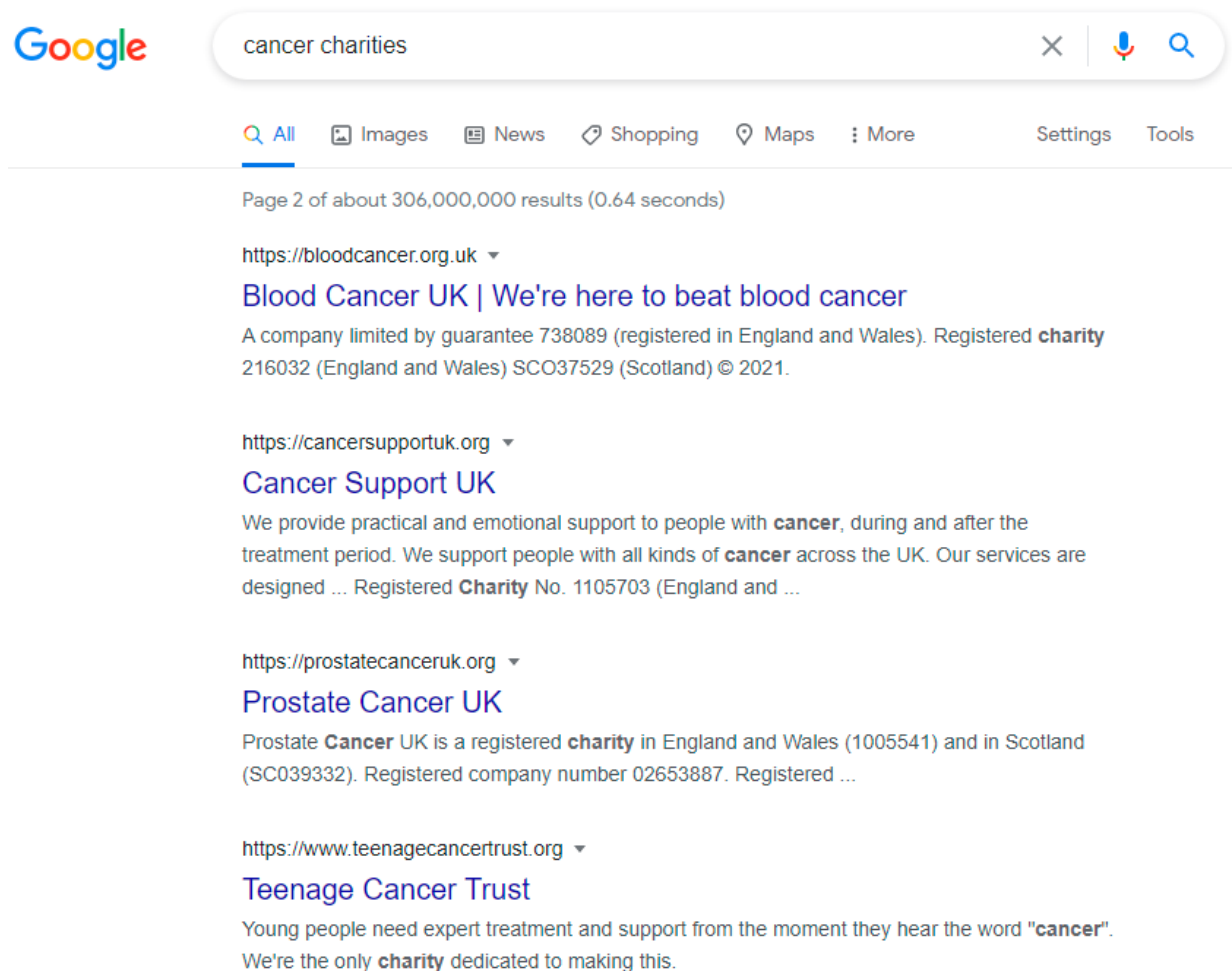

Figure 1: Image of search results ranked by Google

Google, Bing and Yandex return search results in a hierarchical order, based on an assessment by their algorithms (which we cover in the next section) of relevance to the search, location, historical preferences of the searcher, locally highly clicked results, and more. This method of publishing websites in an order that relates to their perceived relevance is called search engine ranking.

It is exceptionally rare for content to rank well immediately on a poorly technically optimised website.

It is also rare for content, which has been given a boost for freshness (recency) by Google, to remain highly ranked in search results with no user interaction.

Content does not rank well simply because it has been authored by an expert. For content to rank, it requires links from other websites, journalists to reference it (even without a link), and relevance to the website as a whole.

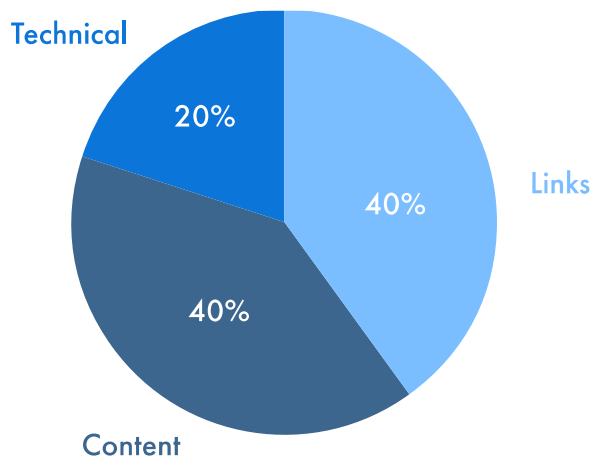

Figure 2: Breakdown of weighting Google places of the three different aspects of ranking according to many SEO experts

2.3 Search visibility

When an SEO talks about visibility, they often refer to a neutral search result pulled by a tool ostensibly free of personalisation.

It is impossible to have a true neutral result because every browser in every location, on a mobile or desktop, is subject to personalisation based on location, past behaviour (through cookies) and other factors.

Understanding how the content being created will display to searchers is important.

It is possible to see how content is ranking using "incognito" browsing in Chrome or "Private" browsing in Firefox. The easiest way to use "incognito" or "private" mode is to right-click on the browser icon and select "New incognito window" or "New private window". This will open a new browser window which will not save 'cookies' (a small piece of data saved on a user's computer by the browser).

For more information on private or incognito browsing here are some useful links from Google and Mozilla.

[Chrome incognito](#)³

[Firefox private mode](#)⁴

If utilising a browser on a computer which has been used to click a website often, Google will skew the results, favouring the most clicked website more highly and make it seem like content is performing better than it truly is. Incognito and Private browsing modes prevent cookies affecting the search results and will show a slightly truer result. However, the IP detected will result in some personalisation.

³ Source: <https://support.google.com/chrome/answer/95464?co=GENIE.Platform%3DDesktop&hl=en>

⁴ Source: <https://support.mozilla.org/en-US/kb/private-browsing-use-firefox-without-history>

Delivering reports and demonstrating results without the browser skewing the search results based on your own click history will ensure a more realistic example of content visibility in search, as will rankings from tool such as Google Search Console when filtered by country.

2.4 Searchers needs revealed in search terms







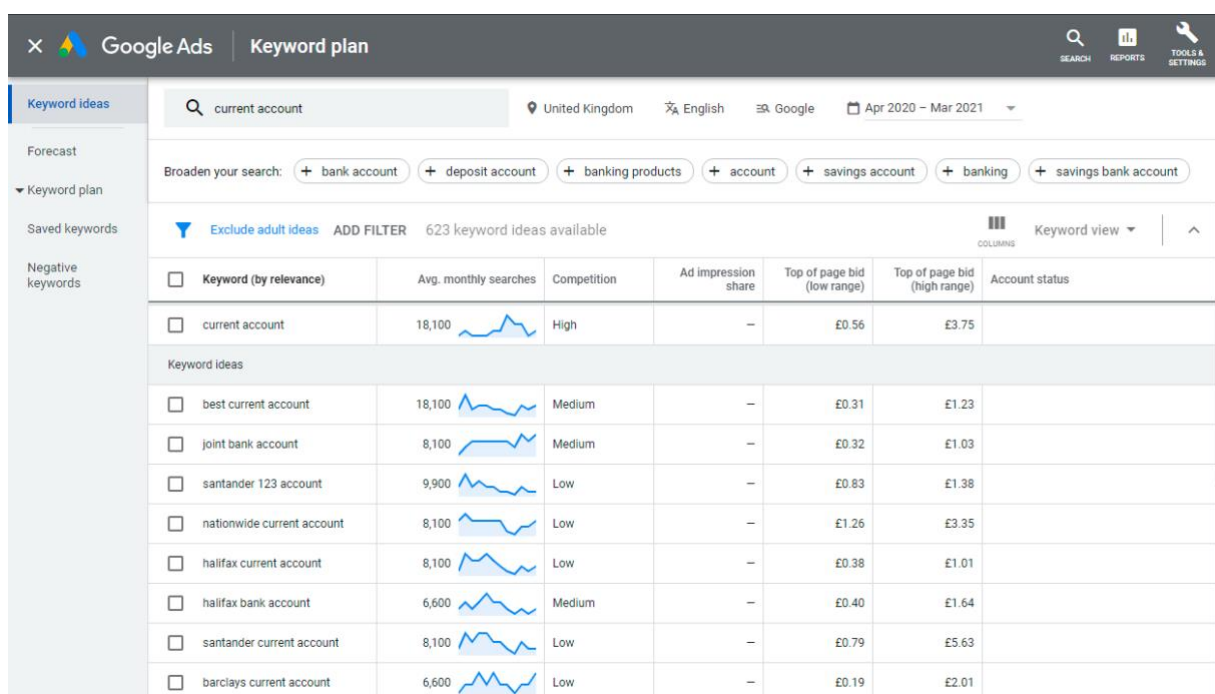

When keyword research is performed (covered more fully in the section on Keywords later on), this can reveal a lot about the searchers' needs, pain points, and the potential solutions a business could offer.

People often go to Google to ask a question to help solve a problem, answer a genuine question, or because they have a specific need for which they do not currently have a brand affinity.

These millions of searches daily are recorded, anonymised, and their volumes recorded by Google. They are made publicly accessible through the Google Ads keyword research tools which are then cascaded through to other tools. It is worth stating that Google does not disclose the exact number of searches through these tools.



The screenshot shows the Google Ads Keyword Planner interface. The search term is 'current account' for the United Kingdom in English, covering the period from April 2020 to March 2021. The interface includes a search bar, filters for 'Exclude adult ideas', and a table of 623 keyword ideas. The table columns are: Keyword (by relevance), Avg. monthly searches, Competition, Ad impression share, Top of page bid (low range), Top of page bid (high range), and Account status. The table lists several keyword ideas with their respective search volumes and competition levels.

<input type="checkbox"/> Keyword (by relevance)	Avg. monthly searches	Competition	Ad impression share	Top of page bid (low range)	Top of page bid (high range)	Account status
<input type="checkbox"/> current account	18,100 	High	—	£0.56	£3.75	
Keyword ideas						
<input type="checkbox"/> best current account	18,100 	Medium	—	£0.31	£1.23	
<input type="checkbox"/> joint bank account	8,100 	Medium	—	£0.32	£1.03	
<input type="checkbox"/> santander 123 account	9,900 	Low	—	£0.83	£1.38	
<input type="checkbox"/> nationwide current account	8,100 	Low	—	£1.26	£3.35	
<input type="checkbox"/> halifax current account	8,100 	Low	—	£0.38	£1.01	
<input type="checkbox"/> halifax bank account	6,600 	Medium	—	£0.40	£1.64	
<input type="checkbox"/> santander current account	8,100 	Low	—	£0.79	£5.63	
<input type="checkbox"/> barclays current account	6,600 	Low	—	£0.19	£2.01	

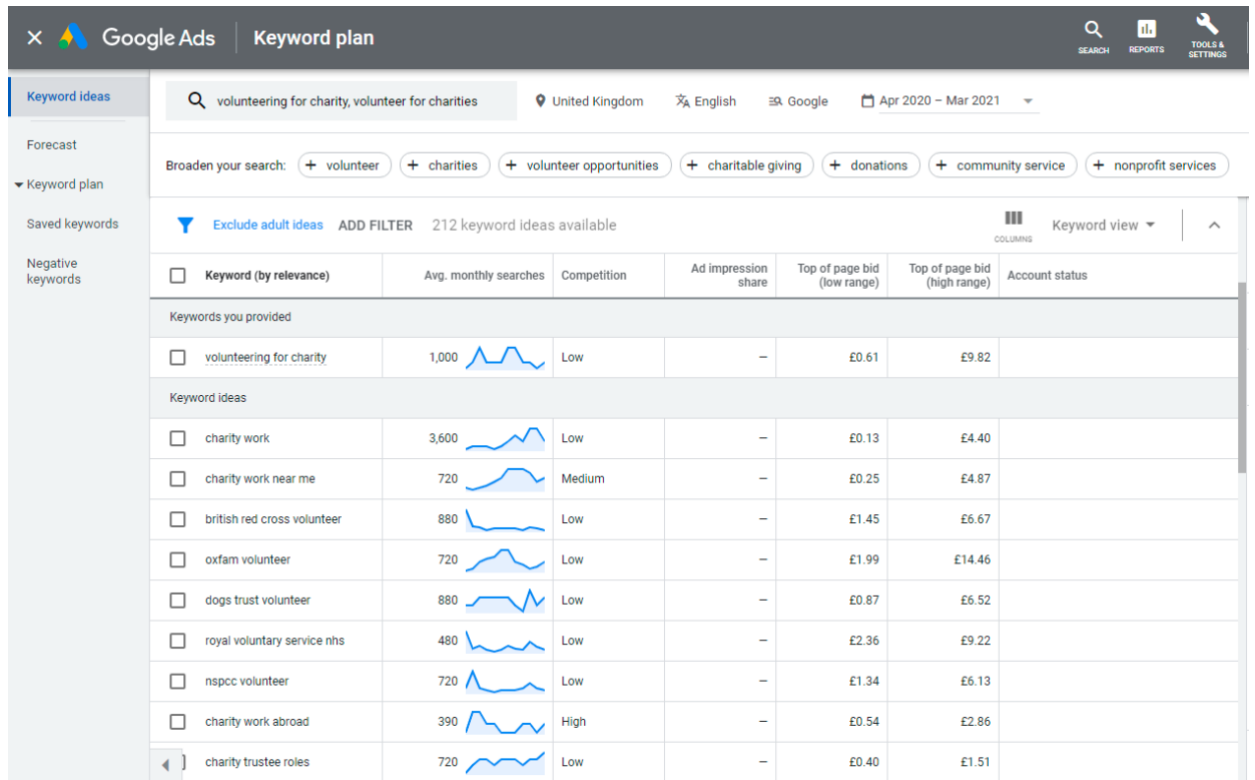

Figure 3: [Google Ads Keyword Planner Tool](https://ads.google.com/intl/en_uk/home/tools/keyword-planner/)⁵

⁵ Source: https://ads.google.com/intl/en_uk/home/tools/keyword-planner/

How Google Works

So, how does Google access and decide how to rank web content?

In this section, we'll look at how Google works at a high level.

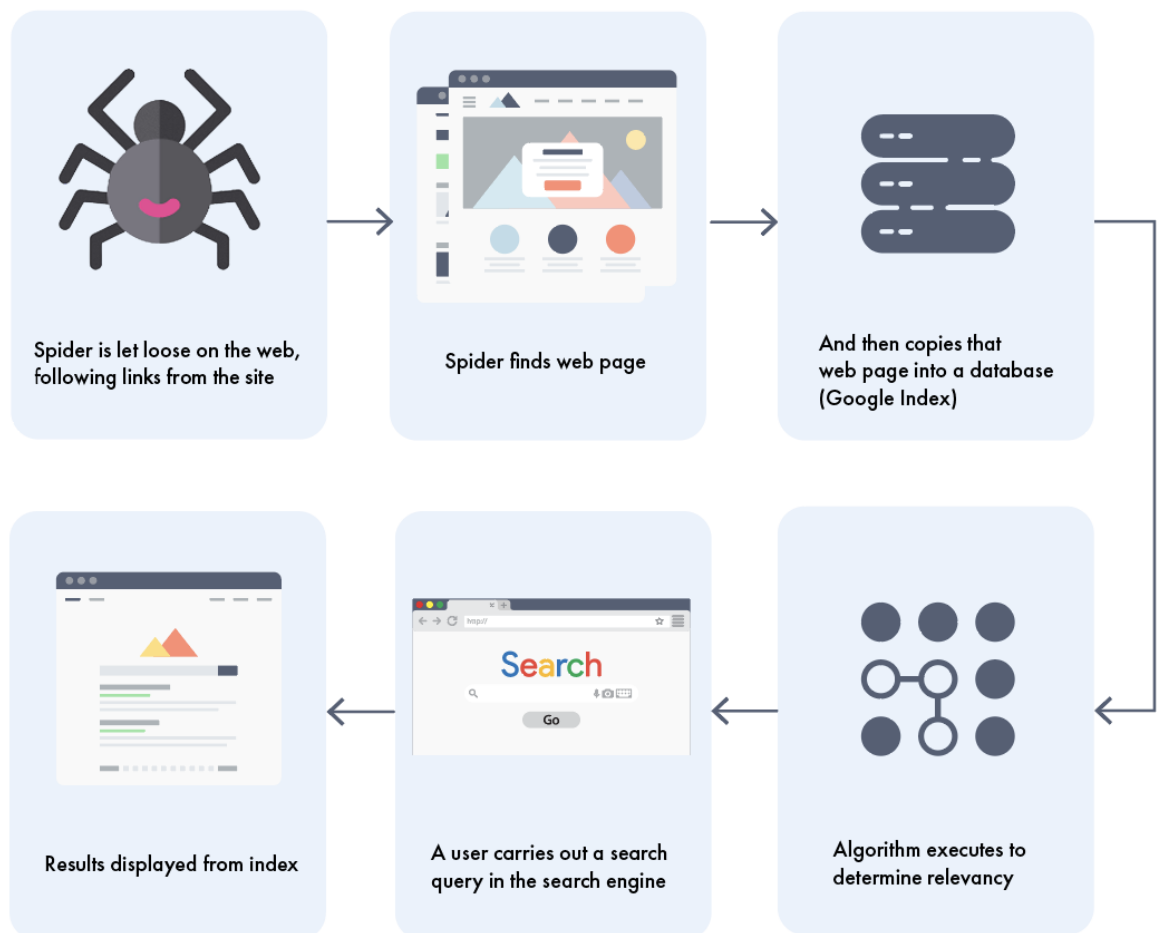

Figure 4: Illustration of how Google search works

3.1 Spiders

A spider is actually a program that connects to web servers and checks to see if there is a webpage and then grabs all the content for storage in the search engine's database.

The spider cannot do anything active such as clicking something (although it can follow most links), entering a password, or un hiding content such as scrolling a page for lazy-loaded content.

Be aware when creating content about the limits of spiders. Publishing content that is not able to be accessed by a search engine crawler/spider means the content will not be available to searchers using a search engine, restricting the discovery of that content.

3.2 Database/Index

A search engine like Google stores the information on each page it has collected in a database or index. In order to make things go faster, it stores and pre-processes the content - and that helps then quickly establish relevance.

It is important to note that Google's database or index is not updated in real-time.

How frequently a website is updated will determine how often Google revisits it to check for changes and add it to its index. If the site remains static for long periods of time, Google is less likely to revisit. If the site is updated regularly, then Google and other search engines will revisit the site.

The change rate of a website does not necessarily affect rankings of new or existing content, but it can affect when that content becomes available in the search results.

On average, the number Google Search queries each second is about 40,000, which means there are more than 3.5 billion searches per day. The potential for discovery of content is high as long as it is available for searchers.

3.3 Algorithms

Algorithms are the unique and complex way Google, Bing, and Yandex figure out how to rank the various web pages that are a match for a set of words entered into search.

Google's algorithm has over 200 factors that are utilised to measure the relevance of each page (it is more complex than this) and this is largely what determines where a page ends up ranking.

Some of the most important elements the algorithm measures are the words on the page, and the links to the page.

Links and content are assumed by some to represent around 40% each of the ranking factors, with the remaining 20% being technical optimisation of a website. There is significant opportunity for PRs to help improve the SEO of a website through content and inbound links.

3.4 E-A-T Ratings of Content

E-A-T is the common acronym used for the important assessment elements of Expertise, Authoritativeness, and Trustworthiness that Google uses to weigh up the content to rank it.

The amount and quality of website content, information, and 'reputation' all inform the E-A-T of a website which is ascribed to the site by Google. While not a direct ranking factor itself, E-A-T (Expertise, Authority, Trustworthiness) includes elements that are used for ranking and serve as a useful guide to content creation to help ensure it ranks well.

3.4.1

Expertise of the author



Figure 5: Example of how an author is denoted on a webpage on the Vuelio website and blog⁶

Is the author of the content an expert in the area that is being covered, for example, does the author hold recognised certification?

Experts can exist in any field and can establish that expertise through contributing user-generated content to various sites. Generally, there are no broad experts. One person may have recognised expertise in more than one topic. For example, the author of this guide has recognised expertise in SEO and chocolate, both industries lacking recognised certification.

Some people share very in-depth and detailed reviews and this can contribute to them being considered experts for sharing their “everyday expertise”.

3.4.2

Is the web page Authoritative?

Users expect to see the most relevant content for their query and so search engines are constantly trying to find the most authoritative and relevant sources to match user needs.

Search engines judge the relative authority for the topic of a search query of all the possible pages that they could display and so need to assess relevance and authority at a huge scale.

For simplicity, when talking about authority, search engines are looking at two main categories:

1. The relevance of the content to the search

2. **Links** - the number and quality of links and whether the sites linking are 'authoritative' websites

'Authority' is also linked to reputation and quality. So let's explore this a little more.

There are 10,000 people employed globally by Google as 'Quality Raters' (QR).

⁶ Source: <https://www.vuelio.com/uk/blog/prca-pr-trends-event-optimism-and-opportunity-for-pr-professionals-in-2021/>

Their task is to rate a webpage in the search results based on relevance to the search, the traceable authority of the website through research they carry out, and more. They work to a set of publicly available guidelines that can be accessed from this page.⁷

Quality Raters cannot alter Google’s results directly, but the data generated by quality raters helps to improve Google’s automated search algorithms.

This extensive document shows the scrutiny every page of a website is under. These auditors are encouraged to utilise reputation research in order to find out what real users as well as experts, think about a website.

Very positive reputation is often based on awards or recommendations from known experts or professional societies. In some industries such as recipes, gossip, humour, etc. it is ok to have a less formal reputation and still be considered an authority on a topic. In the case of less formal expertise, websites can be considered to have a positive reputation if they are highly popular and well-loved for their topic.

Quality raters will research for independent reviews, locate references to the author or website, locate (if possible) recommendations by experts of the website or author, find relevant news articles, and they will work to find any other credible information about the individuals and/or the website.

If they do not find what they are looking for they will down-rate the page and it is likely to slip in the rankings. It is therefore essential to audit your website and the content you publish to ensure the points the QRs are looking for are present. If not, develop a plan to plug any gaps.

Here’s an excerpt from Google’s Search Quality Evaluator Guidelines:



Webpage/Type of Content	Highest Quality Characteristics	PQ Rating and Explanation
Highest: Medical 2 Page about meningitis (YMYL)	<ul style="list-style-type: none"> Very high level of E-A-T for the purpose of the page Very positive reputation (website) 	 This is a meningitis reference page on a trustworthy and authoritative website for a nonprofit medical research group. This website has a reputation of being one of the best web resources for medical information.
Highest: Medical 3 Page about seasonal flu (YMYL)	<ul style="list-style-type: none"> Very high level of E-A-T for the purpose of the page Very positive reputation (website) 	 This is an influenza reference page on a trustworthy and authoritative medical website.
Highest: Charity Homepage of a charity (YMYL)	<ul style="list-style-type: none"> Very high level of E-A-T for the purpose of the page Very positive reputation (website) 	 This is a highly reputable charity according to multiple charity rating organizations.

Figure 6: Google’s Search Quality Evaluator Guidelines highlights how webpages should be rated by its Quality Raters⁸

⁷ Source: <https://support.google.com/websearch/answer/9281931?hl=en>

⁸ Source: <https://support.google.com/websearch/answer/9281931?hl=en>
<https://static.googleusercontent.com/media/guidelines.raterhub.com/en//searchqualityevaluatorguidelines.pdf>

3.4.3 Is the website Trustworthy?

A website's 'on-page' trust signals are thought by SEOs to include things such as a complete "About" page, contact information which can be used to contact the company directly, not just through a form, and well-written privacy policies.

These signals are more important for certain types of sites, where consumer or client trust needs to be built and where customer service is a critical factor – for example, financial or e-commerce brands and websites.

It won't hurt to add trust signals to your own website.

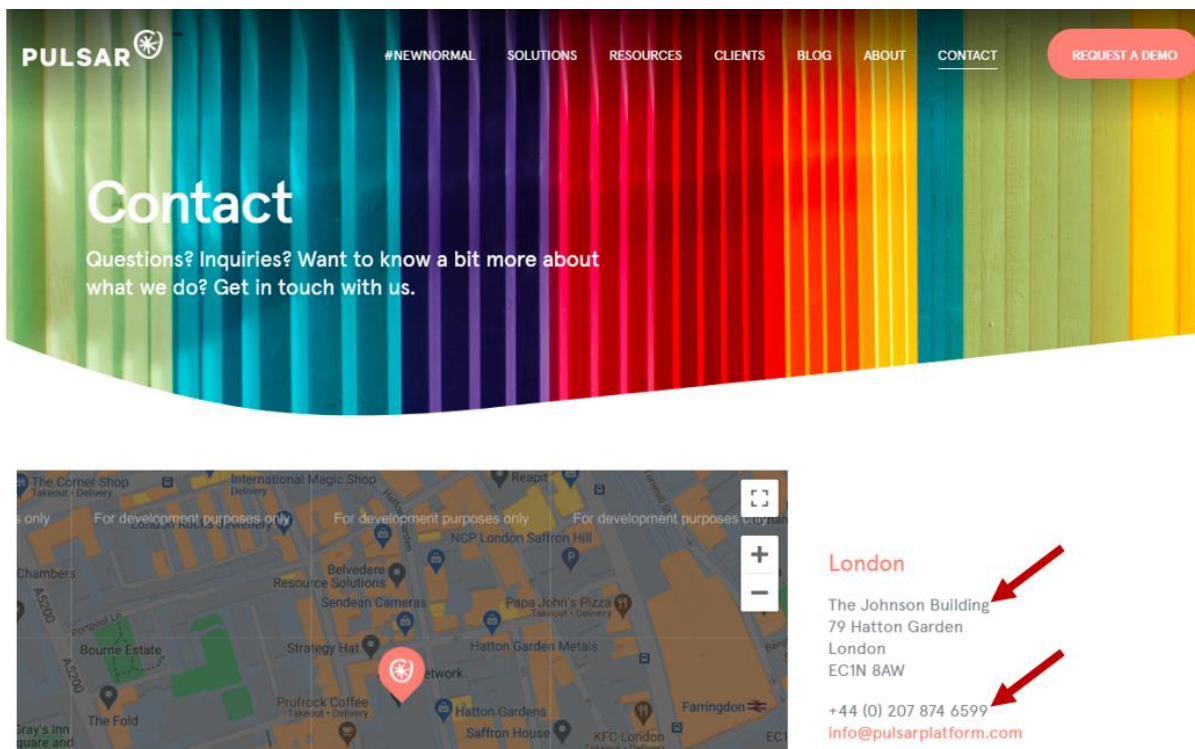

Figure 7: The Pulsar website provides detailed contact information- a recognised Trust element for Google⁹

⁹ Source: <https://www.pulsarplatform.com/contact/>

How to Build a PR SEO Strategy

4.1 Understand the signals Google looks for

Google uses links to determine the relevance and value of a site. PR and communications professionals can deliver links through coverage in relevant publications.

Google needs content to understand what a site is about and to evaluate the relevance of that site to a searcher – PR and communications professionals can deliver content that is well-targeted, authored by experts in their field, and is well-structured and focused.

This section will explore this a little more.

Google, looks at around 200 different signals, of which the SEO industry has guessed at around 50 or so. The types of signals Google looks for are often within the control of PR and communications professionals to influence, including content-related signals (keyword-focused content) and off-site signals (links).

Google is looking for links to websites within content from relevant sites in relevant regional locations, content that is relevant to the topic it purports to cover, content that is well-written and focused around solving problems or addressing the specific topic which is signalled by the keywords in the title tag, H1, and on the page itself.

While an oversimplification, these are the basic signals. These signals are covered in more detail in the 'Optimising content specifically for the web' section of this guide

4.2 Technical web elements you need to know

Technical SEO is a specialism that few PR and communications professionals will need to know in depth, but it is important to understand some of the basic principles.

A poorly built and maintained website could render itself invisible to Google. This can and does happen.

Even if you are not technically minded, it is important to be able to spot this and understand that achieving any visibility KPIs will be seriously impacted. By doing this one simple search, it will show what pages of a website are indexed in Google:

site:yourwebsite.com

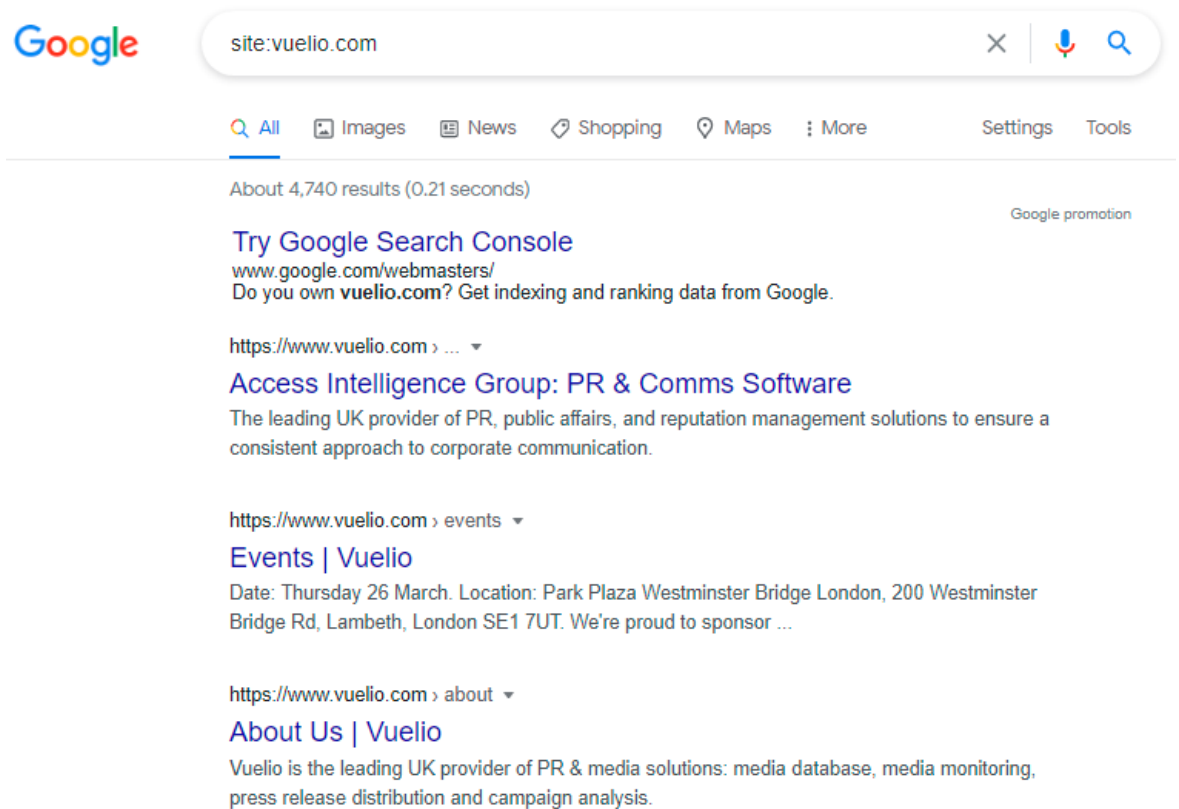

Figure 8: Example of a site search in Google for the Vuelio website

This search has no spaces. Replace the “yourwebsite.com” part with your website or the client you are working with/for. If no results are returned, or if there is a noted issue, it will be difficult for PR and communications professionals to produce any meaningful change to visibility in search and it is likely that the site has technical issues that will need to be resolved.

A website must respond quickly and page speed is a ranking factor.

Google does have tools to help measure speed. If you do not have access to the Google Search Console (a more technical tool that is Google’s analysis of a website), you can check a website’s speed using Google’s ‘Page Speed Insights’ tool:

<https://developers.google.com/speed/pagespeed/insights/> or <https://gtmetrix.com/>

PageSpeed Insights analyses the content of a web page, then generates suggestions to make that page faster.

If the site you are posting content to is a slow site, it may not rank well. Slow sites could face more difficulty from May 2021 as Google updates its algorithm and to include a factor called Page Experience. This update will include additional ranking factors associated with on-site user experience, including page load speed.¹⁰

4.3 Planning out the overlap to create a SEO PR strategy

There are many forms a PR strategy which overlaps with SEO can take.

¹⁰ Source: <https://www.searchenginewatch.com/2021/01/04/google-page-experience-update-is-all-set-to-launch-in-may-2021-webmasters-hang-in-there/>

An SEO SWOT analysis can give a good indication of how likely content is to rank well for the target keywords.

4.3.1 Competitor Keyword Analysis

Check the keywords that competitors are ranking for where a client’s or your website does not rank but should.

Then prioritise the development of content that is relevant to you, your clients/prospects/publics needs and their searches.

Keyword	1	2	3	4	5	Volume	
social media influencer	-	20	-	-	76	18	2,900
american female comedians	-	-	-	-	33	-	1,900
female comedian	-	-	-	-	23	-	1,600
is youtube social media	-	-	-	-	-	33	1,600
social media statistics	-	-	-	-	-	14	1,600
social media calendar	-	-	-	-	-	51	1,300
social media management tools	-	-	-	-	-	59	1,300
social media news	-	-	-	-	-	27	1,300
social media scheduler	-	-	-	-	-	47	1,300
benefits of social media	-	71	-	-	-	-	1,000

Figure 9: Semrush competitor keyword analysis showing who ranks for which keywords¹¹

4.3.2 Competitor backlink analysis

Check where the competition has achieved online coverage, including places they have received links from, in order to see what strategies for online link building could work.

Auditing tools like Semrush and Ahrefs may not be free but they make SEO SWOT analysis easy and efficient.

¹¹ Source: <https://www.semrush.com/>

Referring Domain	AS	Monthly Visits	Matches	0	0	1	14	26
businessinsider.com Business & Industrial > Business Finance > Venture Capital 9 more	85	169M	3/5	0	0	1	14	26
<input type="checkbox"/> New <input type="checkbox"/> Lost <input type="checkbox"/> Follow								
Page AS	Source page Title and URL	Ext. Links	Int. Links	Anchor and Target URL		First Seen	Last Seen	
48	How an ASMR YouTube creator grows her channel, earns money: SemideCoco - Business Insider www.businessinsider.com/how-asmr-youtube-creator-grows-channel-earns-money-semidecoco-2020-12	99	96	top ten YouTube trends for 2020 izea.com/2020/10/08/top-10-youtube-trends-of-2020/		1 Jan'21	30 Jan'21	
43	Sponsored Instagram post price will fall: Influencer marketing agency - Business Insider www.businessinsider.com/cost-of-influencer-marketing-sponsored-instagram-post-expect-drop-coronavirus-2020-3	89	103	new report izea.com/covid19/		22 Apr'20	25 d ago	
32	Sponsored travel content by Instagram, YouTube influencers rebounds - Business Insider www.businessinsider.com/sponsored-travel-content-by-instagram-youtube-influencers-increasing-2020-8	96	97	Izea izea.com/covid-19-thankyou/bg-travel-tourism/?submissionGuid=1d7a02db-eb7d-4566-83b7-dff1fa1bbf50 Izea izea.com/covid-19-thankyou/bg-travel-tourism/?submissionGuid=1d7a02db-eb7d-4566-83b7-dff1fa1bbf50 izea.com/covid19/bg-travel/		29 Sep'20	10 Feb'21	
29	Top 100 Entrepreneurs Who Made Millions Without A College Degree - Business Insider www.businessinsider.com/top-100-entrepreneurs-who-made-millions-without-a-college-degree-2011-1	135	75	Izea Entertainment www.izea.com/		22 Sep'18	19 Feb'21	
<input type="button" value="Show all backlinks"/> <input type="button" value="Show 5 more"/> <input type="button" value="Hide"/>								
cnbc.com News > Business News > Financial Markets 9 more	83	155M	3/5	0	0	2	4	9

Figure 10: Semrush backlink analysis showing coverage and links from competitor sites¹²

Backlink Gap

Root Domain	AS	Monthly Visits	Matches	0	0	2	8	77
dailymail.co.uk News 9 more	86	395M	3/4	0	0	2	8	77
<input type="checkbox"/> New <input type="checkbox"/> Lost <input type="checkbox"/> Follow								
Page AS	Source page Title and URL	Ext. Links	Int. Links	Anchor and Target URL		First Seen	Last Seen	
20	Elizabeth Day: When Christmas isn't all it's cracked up to ... www.dailymail.co.uk/home/you/article-7797413/Elizabeth-Day-Christmas-isnt-cracked-be.html	22	443	wickeduncle.com wickeduncle.com/		14 Dec'20	25 Jan'21	
				Wicked Uncle - Gifts for Boys & Girls - Brilliant Children's Toy wickeduncle.com/		14 Dec'20	25 Jan'21	
<input type="button" value="Show all backlinks"/> <input type="button" value="Hide"/>								
bt.com Internet & Telecom > Service Providers > Phone Service Providers 9 more	76	46.4M	3/4	0	0	6	18	102

Figure 11: Semrush showing competitor backlinks from Daily Mail¹³

Looking at the links (also called backlinks) that competitors have received from other websites can reveal techniques or strategies that the competition may have employed to build visibility through links. Use this information to analyse the number and quality of the links and consider how you could emulate or improve upon this.

¹² Source: <https://www.semrush.com/>

¹³ Source: <https://www.semrush.com/>

4.3.3 Find and fix keyword cannibalisation

Keyword cannibalisation means that a website has blog posts or articles that are ranking for the same search query. If you optimise too many posts or articles for similar search queries, they will eat away at each other's chances to rank - hence the term 'cannibalisation.'

Look at the content on a clients or your website, and consider where consolidation might be required.

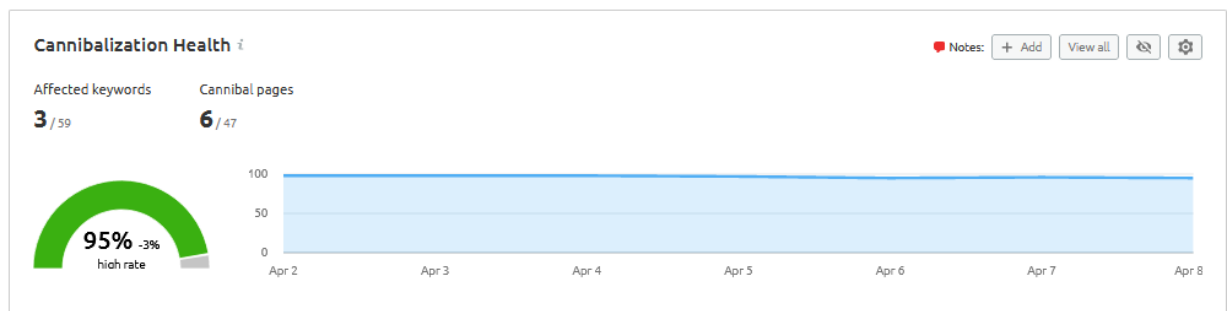

Cannibalization 1-6 (6) Pages Keywords

Cannibal Page	Affected Keywords	Avg. Position	Diff	Total Est. Traffic	Diff	Total Volume
http://mostiyaboutchocolate.co...racciatellabox/	1	56	new	0.01	new	90
http://mostiyaboutchocolate.co.../stracciatella/	1	55	↑2	0.01	0	90
http://mostiyaboutchocolate.co...int-coffee-bag/	1	12	0	0.11	0	210
http://mostiyaboutchocolate.co...dvent-calendar/	1	47	new	0.01	new	50
http://mostiyaboutchocolate.co...dvent-calendar/	1	46	↑7	0.01	0	50
http://mostiyaboutchocolate.co...coffee-review/	1	11	0	0.14	0	210

Figure 12: Using Semrush to identify where the same keyword ranks for different pages called 'cannibalisation'¹⁴

Use a free tool like Google Search Console (GSC) if you have access and are comfortable with it to see what keywords are relevant to multiple pages. Paid for tools like Semrush can help you see where the same keyword has more than one URL linked to it.

This may indicate that different pages rank, sometimes badly, for the same keyword and may offer an opportunity for consolidation.

Keep the URL with the most links when combining content from multiple URLs into a single page unless a different page ranks better, then keep that URL.

¹⁴ Source: <https://www.semrush.com/>

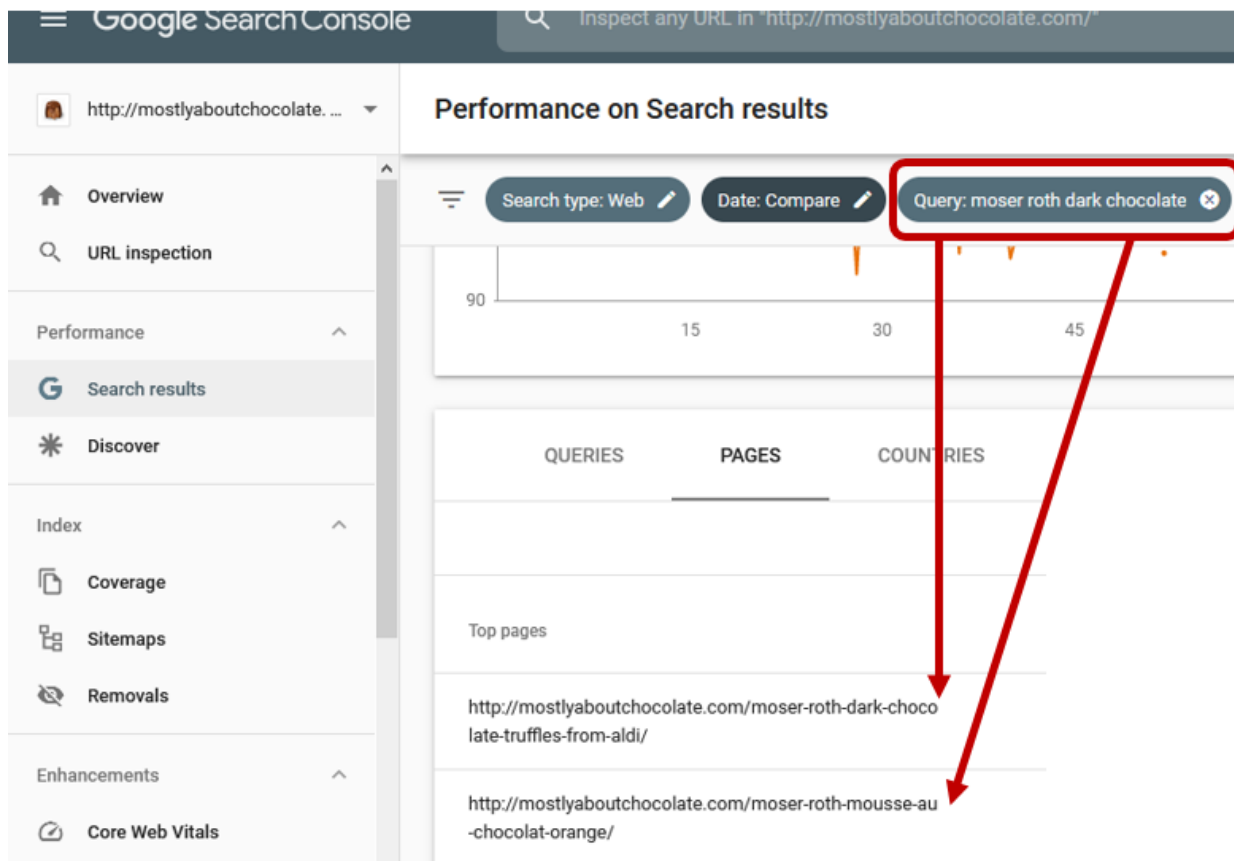

Figure 13: Google’s Search Console shows multiple pages ranking for the same keywords where consolidation may work

If you don’t have access to Semrush or another tool called Seomonitor, but do have access to GSC, you could use Hannah Butler’s data studio tool for finding keyword cannibalisation.¹⁵

¹⁵ Source: <https://strategiq.co/how-to-identify-keyword-cannibalisation/>

Keywords, Content, and On-Page Essentials

Utilising keywords in copy does not mean stuffing keywords into copy in the hope that having all those words in there would make it rank.

Although that might have worked in the very early 2000s the opposite is true today with Google utilising sophisticated grammar and language algorithms to analyse content and rate it according to grammatical, spelling, language and semantic factors.

Keywords are part of designing content which will attract visitors to a website who are looking for a product, service, solution or information offered.

Discovering content is only possible if the content contains at least one mention of the target keyword.

However, writing naturally is important, with Google and other search engines analysing content for semantically related words to the focus keyword, and utilising this analysis to better rank and surface the content.

Sewing machine

A **sewing machine** is a **machine** used to **sew fabric** and materials together with **thread**. Sewing machines were invented during the first Industrial Revolution to decrease the amount of manual **sewing** work performed in **clothing companies**. Since the invention of the first sewing machine, generally considered to have been the work of **Elias Howe** and Englishman **Thomas Saint** in 1790, the sewing machine has greatly improved the efficiency and productivity of the **clothing industry**.

Home sewing machines are designed for one person to sew individual items while using a **single stitch** type at a time. In a modern sewing machine, the process of **stitching** has been automated so that the **fabric** easily glides in and out of the machine without the inconvenience of **needles, thimbles** and other tools used in hand sewing. Early sewing machines were powered by either constantly turning a handle or with a **foot-operated treadle** mechanism.

Figure 14: This example highlights how Google understands language

5.1 Understanding keywords from Google's point of view

Google is constantly working towards delivering the best, most relevant results for any user's query.

While that includes factors such as links and the technical stability of the site, it also includes: the relevance of the content to the query which is measured not only in keywords on page, but also semantically related words to the target keyword; the relevance of the content to the section of the website it is in; the relevance of the content to the website as a whole; and a variety of other factors such as E-A-T.

Optimised Title Tags, H1s, content, and targeting one topic per page are all essential in creating a well optimised page. Of course, in order to rank well, a page on the web still needs links. This factor is covered in the section on links below.

Understanding the specific questions or pain points that need to be addressed will help Google understand what the best page is for the searchers query, as well as helping focus and target the content being created.

As an example, imagine that a webpage is about "chocolate".

Naturally, the first question is what kind of chocolate as chocolate is a broad term, encompassing a possible query about what it is, e.g. luxury, vegan, milk, dark, fair trade etc.

Or it could relate to various stages purchasing chocolate, e.g. chocolate and wine pairing, chocolate wedding gift delivery UK or where chocolate comes from, or in fact many other sub-topics.

5.2 Keyword research and different ways to do it

Google is not the only search engine, but it is certainly the main one and therefore most tools focus on Google search volumes.

There are a number of free tools however there are limits on the number of keywords returned, and the relevance of those results. Some give many keywords but these lack context such as search volume, others give search volumes but limit their results to 10 or so keywords.

For keyword research, a paid solution is best to help streamline the process, however it is possible to do research for free if access to a Google Ads account is available.

It may sound obvious, but it's important to deeply understand the product or service offering.

- What solution is being offered?
- What challenge does it solve or what opportunities does it open for its customers, users or buyers?
- What is the USP (unique selling point)?
- How people might possibly search for it and its competitors.

An exercise like this can sometimes reveal additional insight that can help with positioning, and may help refine or even adjust the USP.

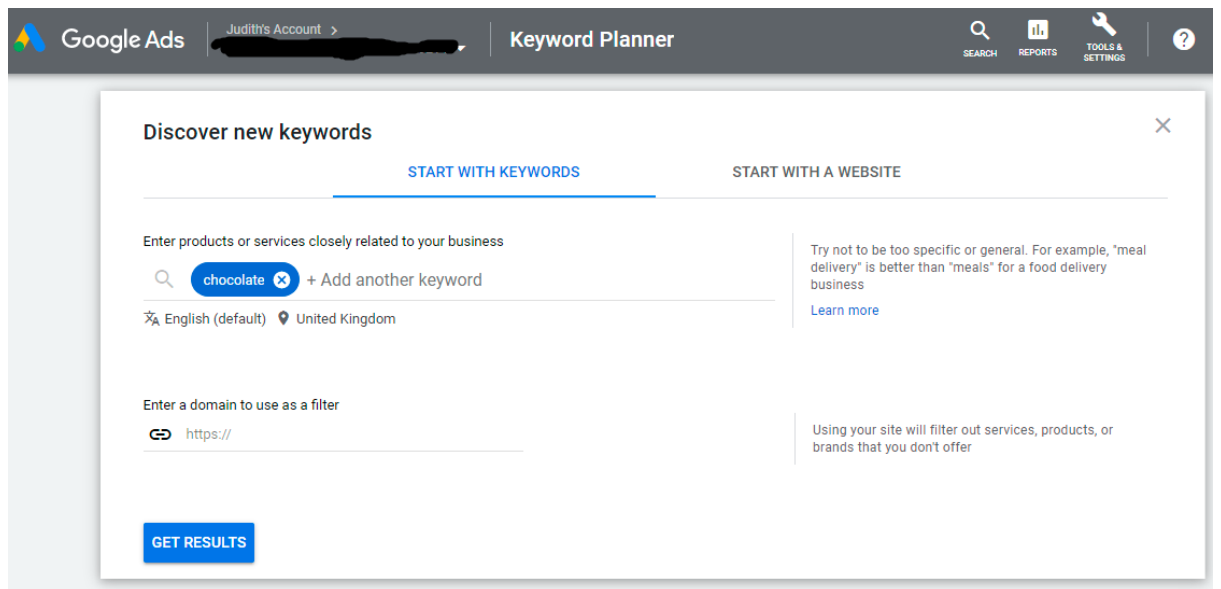

Figure 15: Google Ads Keyword Planner¹⁶

By using the Keyword Planner in Google Ads, it is possible to either add keywords or a website to get keyword suggestions.

Do some brainstorming and come up with a focused list of keywords and use them in the Keyword Planner

This example of keywords resulting from a poorly defined initial keyword of “chocolate” shows why better brainstorming needs to be done initially.

More focused keywords will help the Google Ads Keyword Planner tool to give a better set of results.

¹⁶ Source: https://ads.google.com/intl/en_uk/home/tools/keyword-planner/

The benefit of this tool is that it is free. The seasonality graphs per keyword seen in the page are available from most paid tools and so are accessible elsewhere.

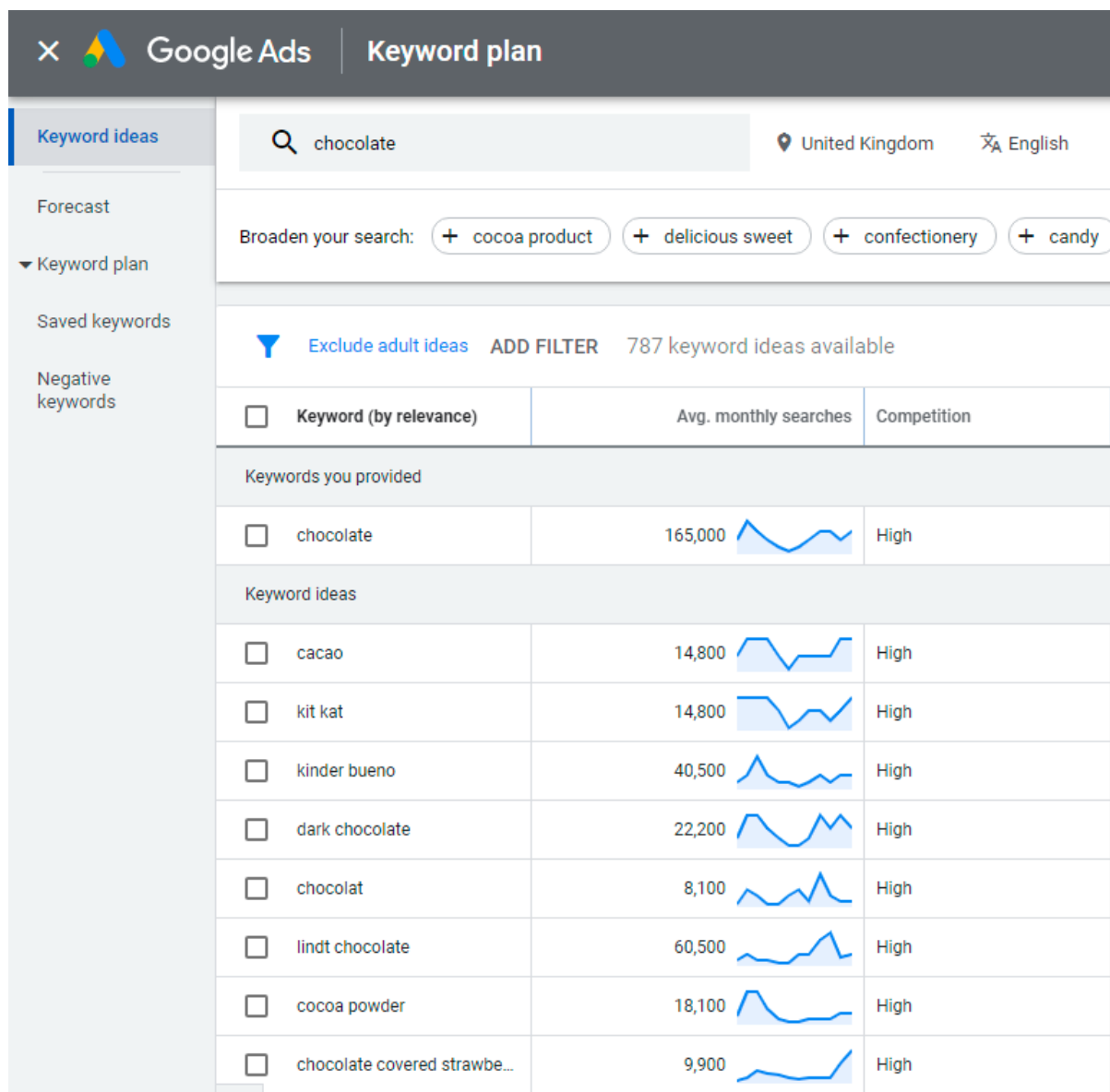

Figure 16: Google Ads Keyword Planner example with single keyword

Paid tools will deliver a more diverse, and better grouped and managed set of keyword results which should help with content creation, competitive analysis, and understanding the gaps.

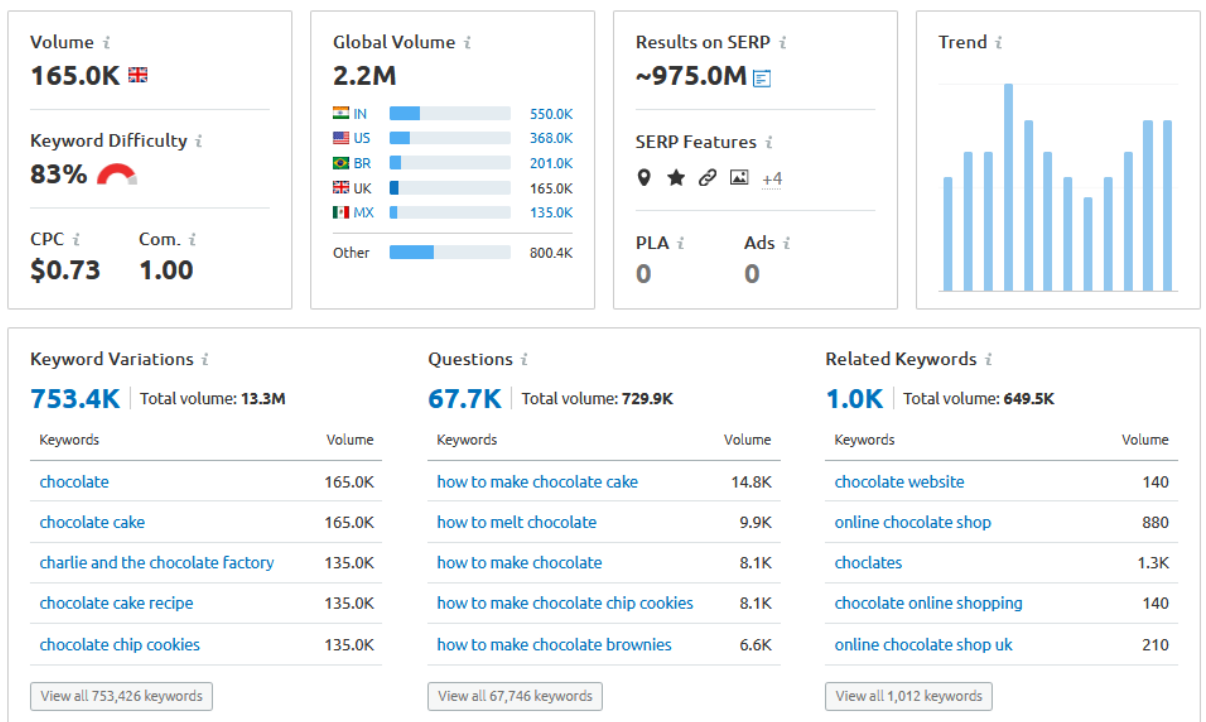

Figure 17: The Semrush tool shows more detailed keyword information¹⁷

When the same single keyword 'chocolate' placed into the paid Semrush tool, the keyword research outcome is quite different. It starts the process of grouping the keywords that are associated with the root word 'chocolate', but also suggests related terms not directly resulting from the initial keyword to help with refinement. It also highlights questions that are being asked along with their search volumes.

Other tools for keyword research include Ahrefs for research like Semrush, and keywordtool.io which is a freemium model keyword research tool.

For advanced keyword intelligence, we recommend that you read this complementary guide from Pulsar on 'Audience Intelligence + Keyword Intelligence = Audience First SEO'¹⁸ and consider how advanced audience intelligence tools like Pulsar can help power your communications, content marketing and SEO strategy alongside social media listening.

¹⁷ Source: <https://www.semrush.com/>

¹⁸ Source: <https://www.pulsarplatform.com/resources/audience-intelligence-keyword-intelligence-audience-first-seo/>

The most-searched-for Electric Vehicle capabilities Can Electric Vehicles...?

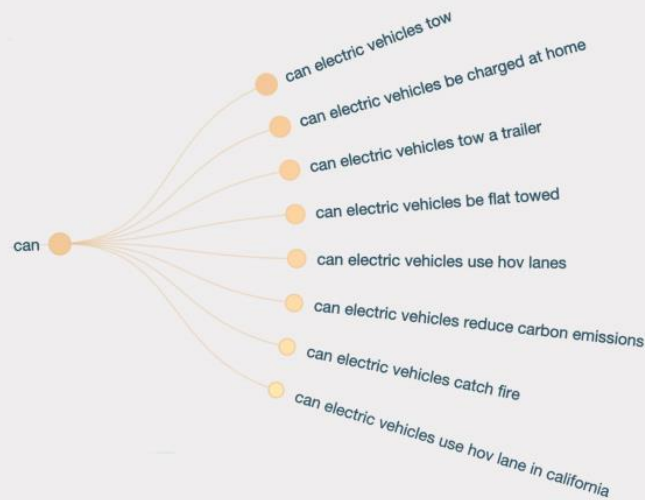

The most popular 'Can' queries relating to Electric Vehicles searched for by the UK and US public, Feb 15 2021 - Apr 5 2021. Source: [Pulsar TRAC](#)

Figure 18: Search Data Insights, a Pulsar feature powered by Google search data, enables you to examine both search and social data in the same tool¹⁹

5.3 Content creation – its purpose and how Google specifically sees it

Content should never just be created for the sake of it, or to cover off keywords. You should develop a strategic plan to follow.

Keywords should focus on addressing customer needs or pain points. If no one is looking for a solution for 'how to buy purple chocolate', creating content for this topic is unlikely to attract much traffic, even if it might attract links.

Map out user or buyer steps for consideration and evaluation before purchase or other form of 'conversion' to help with designing the content. Search forms a significant part of most customer or buyer journeys.

At each of these steps in their journey, an individual will have questions focused around the problem that is attempting to be solved. The problem could be as simple as 'is chocolate good for you?' or as complex as 'boutique digital PR agency specialising in luxury brands and high-end wines'.

¹⁹ Source: <https://www.pulsarplatform.com/resources/audience-intelligence-keyword-intelligence-audience-first-seo/>

5.4 Optimising content specifically for the web

Content that you may have written for other mediums should not necessarily need to be fully rewritten for the web, but there are certain factors which could help Google understand it well and will help optimise the visibility of the content in search.

Title tags, meta descriptions, the first paragraph, jump-to links, and images (expanded on below) all help to create 'content around content'.

While content length has been suggested to be a ranking factor, this is less likely to be purely because of length, and likely more related to language use.

Do not 'stuff keywords' into anywhere on a webpage. Keyword stuffing is not only bad for readers/users, but also bad for search engines and could result in a suppression of rankings, often referred to as a penalty. The recommendations given below for optimising web content assume natural language usage, with good grammar, spelling, and average to above average composition.

It's important to remember that each page of a website is a potential landing page.

It should be targeted towards a single topic, with keywords tightly focused around the single topic of the page. By focusing tightly around a single topic, the keywords will naturally be tightly related and it will be easy to write naturally using semantically related keywords.

When optimising a page, as naturally as possible, work the target keywords into the following places:

Title Tag: Often called the Meta Title, this is the title that is displayed in Google search results and should ideally be under 70 characters with the most important/relevant keywords towards the start of the title. This is used for ranking.

Meta Description: Not used for ranking but absolutely essential for click through rate. This is the 165 characters that will determine whether someone clicks or passes by the search result. Google will eschew this for on-page content if it is not relevant, so it is very important to write this carefully and well.

<https://guild.co> › [blog](#) › [guild-co-blog-prca-uses-guild-...](#) ▼

PRCA powers the communications sector with Guild groups

2 Nov 2020 — The Public Relations and Communications Association (PRCA) uses Guild to host multiple regional groups and workgroups for collaboration ...

Figure 19: The Title Tag on this blog post on Guild.co is 'PRCA powers the communications sector with Guild groups' and Meta Description is 'The Public Relations and Communications Association (PRCA) uses Guild to host multiple regional groups and workgroups for collaboration and engagement.'²⁰

²⁰ Source: <https://guild.co/blog/guild-co-blog-prca-uses-guild-hosting-communities/>

H1: While not a ranking factor, this is often the first thing visitors see when arriving on a page and so it should be concise, cover the topic and possibly (but not a hard rule) contain your target keyword if it is natural to do so. As this is often similar to or the same as the title tag it is usually covered.

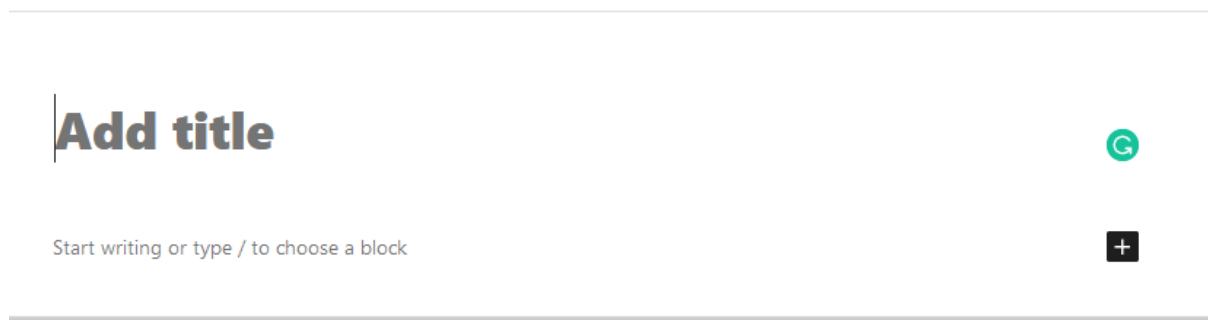

Figure 20: Example of a Wordpress title block which once populated becomes the H1 on page

Content: It is often suggested that the keyword should be placed within the first 100 words. Provided it is in the H1, there is no need to use it again however there is no harm in including it once again if natural to do so. Semantically related words are recognised by Google and results with those words, and not the original keywords searched for, are often returned by Google.

BEAUTY BLOGS UK TOP 10

MARCH 3, 2021
by Holly Hodges

PR PULSE / TOP TEN BLOGS / SOCIAL MEDIA INDEX / TOP LISTS / INFLUENCERS



The Top 10 Beauty Blog ranking was last updated 03/03/2021.

Vuelio uses a proprietary algorithm to create these rankings, based on topic-related content in blogs on its system – you can read more about the process [here](#). Our research team actively seeks out new blogs and bloggers for inclusion, but if you think we've missed someone, please [get in touch](#) to let us know.

Figure 21: Example of optimised content placing keywords in first paragraph²¹

URL: Often the URL will be created from the H1/title tag if using Wordpress, but when using another system such as Magento, Drupal, or others, make the URL as relevant as possible, without repeating any keywords.



Figure 22: Example of an optimised URL²²

²¹ Source: <https://www.vuelio.com/uk/social-media-index/top-10-uk-beauty-blogs/>

²² Source: <https://www.vuelio.com/uk/social-media-index/top-10-uk-beauty-blogs/>

Advanced On-Page SEO

While not necessarily “advanced” in the sense of being very technical, these elements may not be as familiar to content creators and PR and communications professionals as title tags, meta descriptions and H1 elements.

They are elements which are not only a very useful boost to a website’s visibility in search, but they aid further structuring of web content in a logical, helpful manner for people, not just search engines.

6.1 Image alt attributes

The alt attribute, sometimes called an alt tag, is a description of what that image is.

It is possible to optimise an image, both by naming the image file something relevant and keyword rich (such as: salted-caramel-chocolate-bonbon.jpg) as well as ensuring when describing the image, specific keywords are naturally worked into the alt attribute (such as: Image of a single salted caramel chocolate bonbon on a grey slate tile).

If adding a caption to the image as well, try to avoid repetition. The alt attribute is often used by screen readers to describe what an image is so be aware of this when populating this attribute.



```
...<div class="post-meta"></div>
▶<div class="post-share"></div>
▼<div class="post-con">
  ▶<div class="fblike_button" style="margin: 10px 0;"></div>
  ▼<p>
***
     == $0
    "Book credit: Guittard Chocolate Cookbook: Decadent Recipes from San Francisco's Premium Bean-to-Bar Chocolate Company by Amy Guittard and foreword by Alice Medrich (Chronicle Books, £15.99)."
    <br>
    "
    Image credit: © 2015 by Antonis Achilleos"
    <br>
    "
    Link: "
    ▶<a href="http://abramsandchronicle.co.uk/books/food-and-drink/9781452135335-guittard-chocolate-cookbook"></a>
    <br>
    "
    "My aunt Vicki and uncle Peter live about an hour and a half
```

Figure 23: Example of what alt attributes look like in the code of a webpage²³

²³ Source: www.Mostlyaboutchocolate.com

6.2 Schema

Schema is a method of indicating to search engines what a piece of content relates to through adding a small additional bit of text into the content, often by using a plug-in though sometimes manually.

For example, the opening hours of a shop, the date and time of an event, the relationship of a founder to someone else, a location, specific information about an organisation, etc.

The total available schema is large, and it adds to Google's understanding of entities and relationships of entities to each other.

For the complete list of available schema, please refer to the official website at <https://schema.org> which contains a list of all schema possible including ratings, events, breadcrumbs, article, and more.

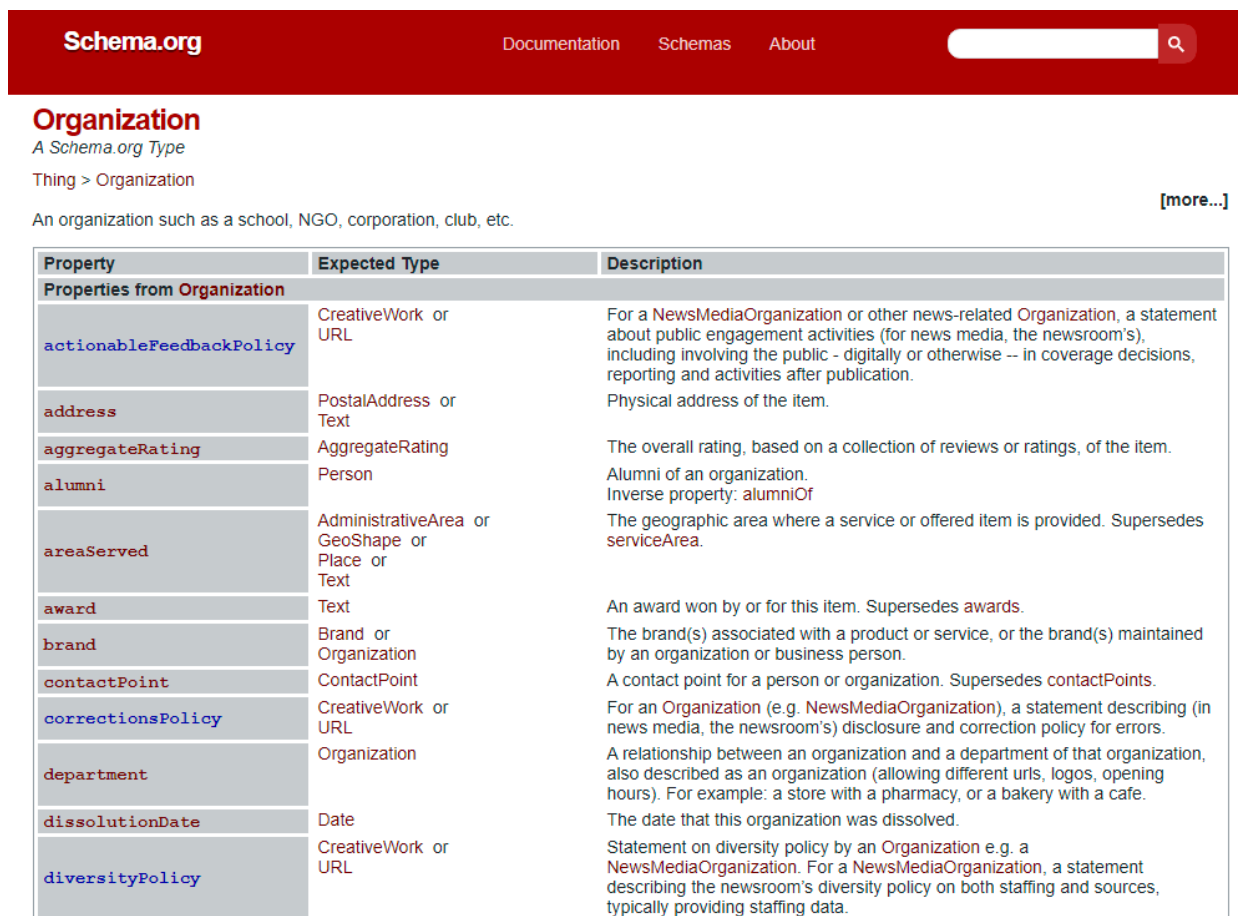

Schema.org Documentation Schemas About

Organization

A Schema.org Type

Thing > Organization [more...]

An organization such as a school, NGO, corporation, club, etc.

Property	Expected Type	Description
Properties from Organization		
<code>actionableFeedbackPolicy</code>	CreativeWork or URL	For a NewsMediaOrganization or other news-related Organization, a statement about public engagement activities (for news media, the newsroom's), including involving the public - digitally or otherwise -- in coverage decisions, reporting and activities after publication.
<code>address</code>	PostalAddress or Text	Physical address of the item.
<code>aggregateRating</code>	AggregateRating	The overall rating, based on a collection of reviews or ratings, of the item.
<code>alumni</code>	Person	Alumni of an organization. Inverse property: <code>alumniOf</code>
<code>areaServed</code>	AdministrativeArea or GeoShape or Place or Text	The geographic area where a service or offered item is provided. Supersedes <code>serviceArea</code> .
<code>award</code>	Text	An award won by or for this item. Supersedes <code>awards</code> .
<code>brand</code>	Brand or Organization	The brand(s) associated with a product or service, or the brand(s) maintained by an organization or business person.
<code>contactPoint</code>	ContactPoint	A contact point for a person or organization. Supersedes <code>contactPoints</code> .
<code>correctionsPolicy</code>	CreativeWork or URL	For an Organization (e.g. NewsMediaOrganization), a statement describing (in news media, the newsroom's) disclosure and correction policy for errors.
<code>department</code>	Organization	A relationship between an organization and a department of that organization, also described as an organization (allowing different urls, logos, opening hours). For example: a store with a pharmacy, or a bakery with a cafe.
<code>dissolutionDate</code>	Date	The date that this organization was dissolved.
<code>diversityPolicy</code>	CreativeWork or URL	Statement on diversity policy by an Organization e.g. a NewsMediaOrganization. For a NewsMediaOrganization, a statement describing the newsroom's diversity policy on both staffing and sources, typically providing staffing data.

Figure 24: An example of some of the potential schema attributes available for web content²⁴

6.3 FAQ Schema

At the time of writing this guide, one type of schema is being utilised to great effect, delivering a much richer search result.

²⁴ Source: <https://schema.org/>

'FAQ schema' was promoted by Google to help deliver answers to commonly asked questions within the search results. Not intended to reduce the click through rate from organic results, it is a way to assist the searcher by enabling them to further refine their query and encourages the click.

FAQ schema for Wordpress is easily implemented through using a simple free plugin from Yoast and adds a block of questions that are authored by the site owner and answered on page.

While the content may be placed anywhere on the page through moving the blocks, it does need to be visible on the page, and relevant to the topic of the page.

The reward for well structured, relevant questions and answers is that they may appear in the search results for relevant queries, making the search result more visible and pushing the competition further down the visible page.

As with everything with Google, implementing does not guarantee inclusion.

<https://www.wickeduncle.co.uk> › presents › boys › age-6 ▾

Exciting Gifts For 6 Year Old Boys | Toys Delivered UK-Wide ...

If you want to buy a cool **gift for a six year old boy** for his birthday, or just because you're feeling kind, we have the perfect selection. We have Pokibots, smart ...

What is the best gift for a 6 year old boy? ▾

What's a good gift for a six year old? ▲

Good gifts for six year olds range from creative kits, magic sets and fun games which make them run around. Our most popular gifts for this age group are a [Giant Bubble Set](#), a [Stinky Pig](#) game or some [Magic Pens](#).

What are the most popular toys for 6 year old boys? ▾

Figure 25: An example of what FAQ schema looks like in Google

6.4 Internal linking

Users use and need internal links to navigate a website.

Whether menu items or in-content, links are critical for people and spiders to move around a site. Content that contains links has those links weighted differently for passing value along to the target page compared to menu links.

Links which appear within a passage of text are assessed along with that co-occurring text in order for search engines to better understand what the target page of the link is likely to be relevant for. This depth of understanding the target page through co-occurring content has helped Google for years in assessing the value of a link, and the value of a page.

Internal linking is one of the most powerful ways to move SEO value around and increase rankings.

It is recommended to not place too many internal links within an article, maintain the relevance of the content, for example, don't suddenly talk about ceramic mugs on a page about wine just to insert a link, and avoid placing a link about extremely similar content within the first paragraph.

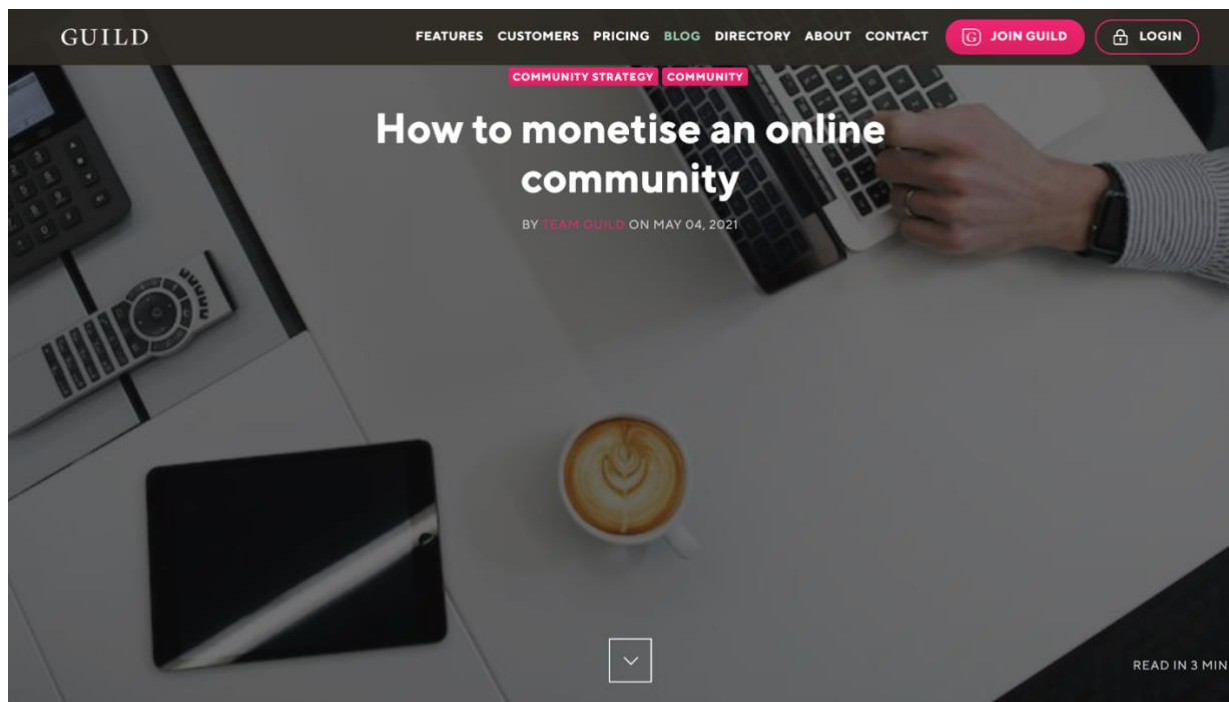

In a time of remote working, digital transformation, and a rise in experts looking to monetise their professional knowledge, online communities are surging in popularity.

Building and growing your own online community can be a great way to create closer, and more valuable, relationships with prospects and customers. However, it is also an investment of both time and money. Particularly as your community grows, you may start to find you need more resources to sustain it. From your community manager's salary, to your tech platform, there are costs to cover, which is why some organisations choose to consider monetising their group. You could even make your community a revenue source.

Figure 26: The phrase 'growing your own online community' is linked internally to another highly relevant page on Guild.co²⁵

6.5 Jump-to links for sitelinks

Targeting fragments of content on a long page can help both Google and people find relevant passages to find the answers they are looking for.

Ignoring for a moment passage indexing, which is simply Google now able to treat content as discrete elements, **jump-to links** are links which simply take a user to a specific place within content on a page. Jump-to links simply jump the clicker to the position on the page that the link is anchored to, instead of just the top of the page.

²⁵ Source: <https://guild.co/blog/how-to-monetise-an-online-community/>

They are usually recognised in the code of a webpage by the '#texthere' section of a URL -for example <https://www.moneysavingexpert.com/insurance/young-drivers/#tip2> which is the example of a jump-to link in the moneysupermarket example below.

The link in this case takes the searcher to tip #2 and not to the top of the page. You can try it out by copying the full URL and pasting it into your browser first with the #tip2 and then without it and you'll see without #tip2 you are taken to the top of the page.

These links are relatively easy to make and are utilised by some longer content pages to help searchers who land at the top of the page find specific sections.

By breaking content up into logical thematic groups on the page, jump-to links can act like a mini table of contents, which in turn helps Google understand what that fragment of content is about. On occasion, jump-to links also appear in Google search results as 'sitelinks' as with the Money Saving Expert example below.

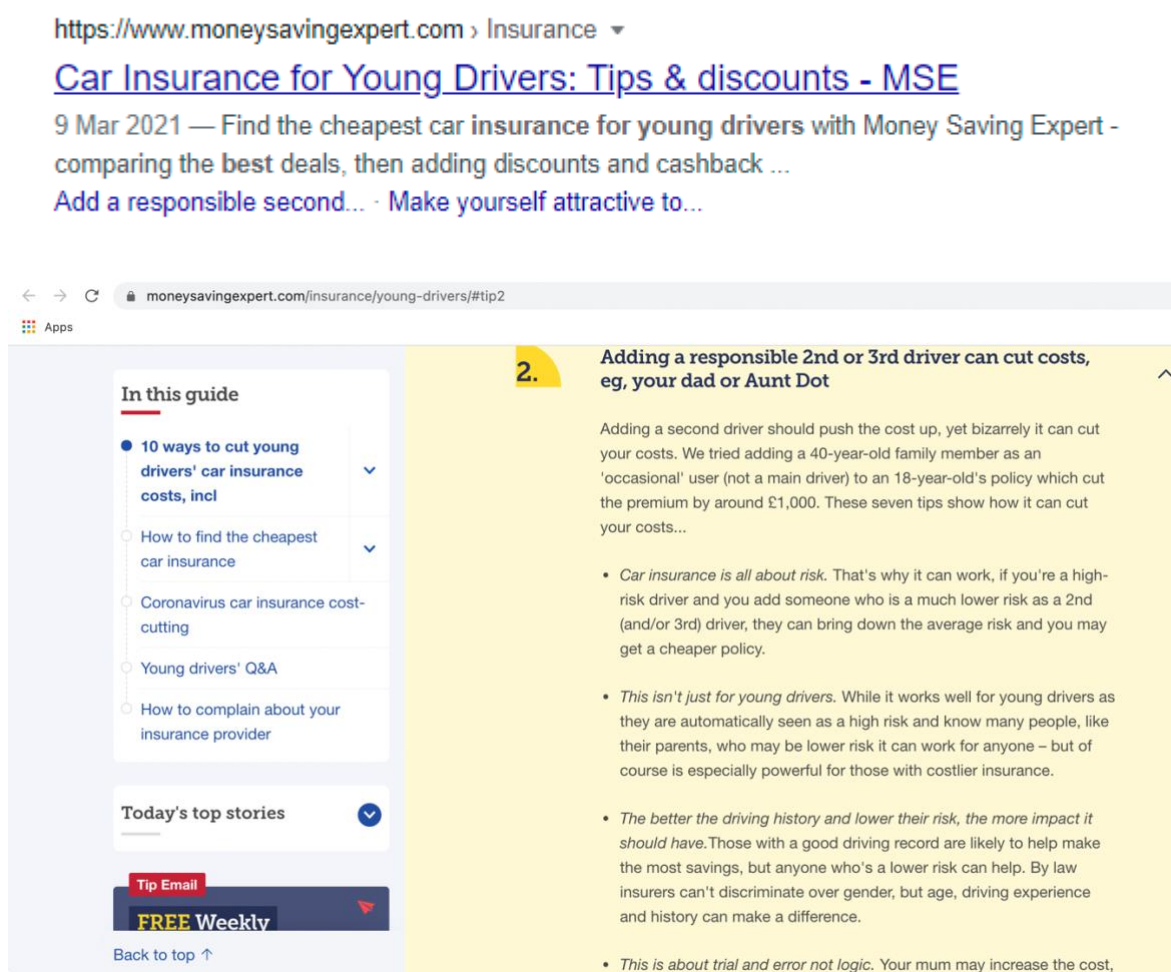

Figure 27: Example of jump-to links as sitelinks links in Google search results and the #tip 2 that 'adding a responsible second....' 'jumps' the clicker to from the search results on the MoneySavingexpert website ²⁶

²⁶ Source: <https://www.moneysavingexpert.com/insurance/young-drivers/>

6.6 Featured Snippet tricks

Featured Snippets are short snippets of text that appear at the top of Google's search results that quickly answer a searcher's query. The content that appears inside of a Featured Snippet is automatically pulled from web pages in Google's index.

Google determines whether a page would make a good featured snippet for a user's search request, and if so, elevates it. For example, this page from the BBC website for a query about Heathrow Airport expansion.

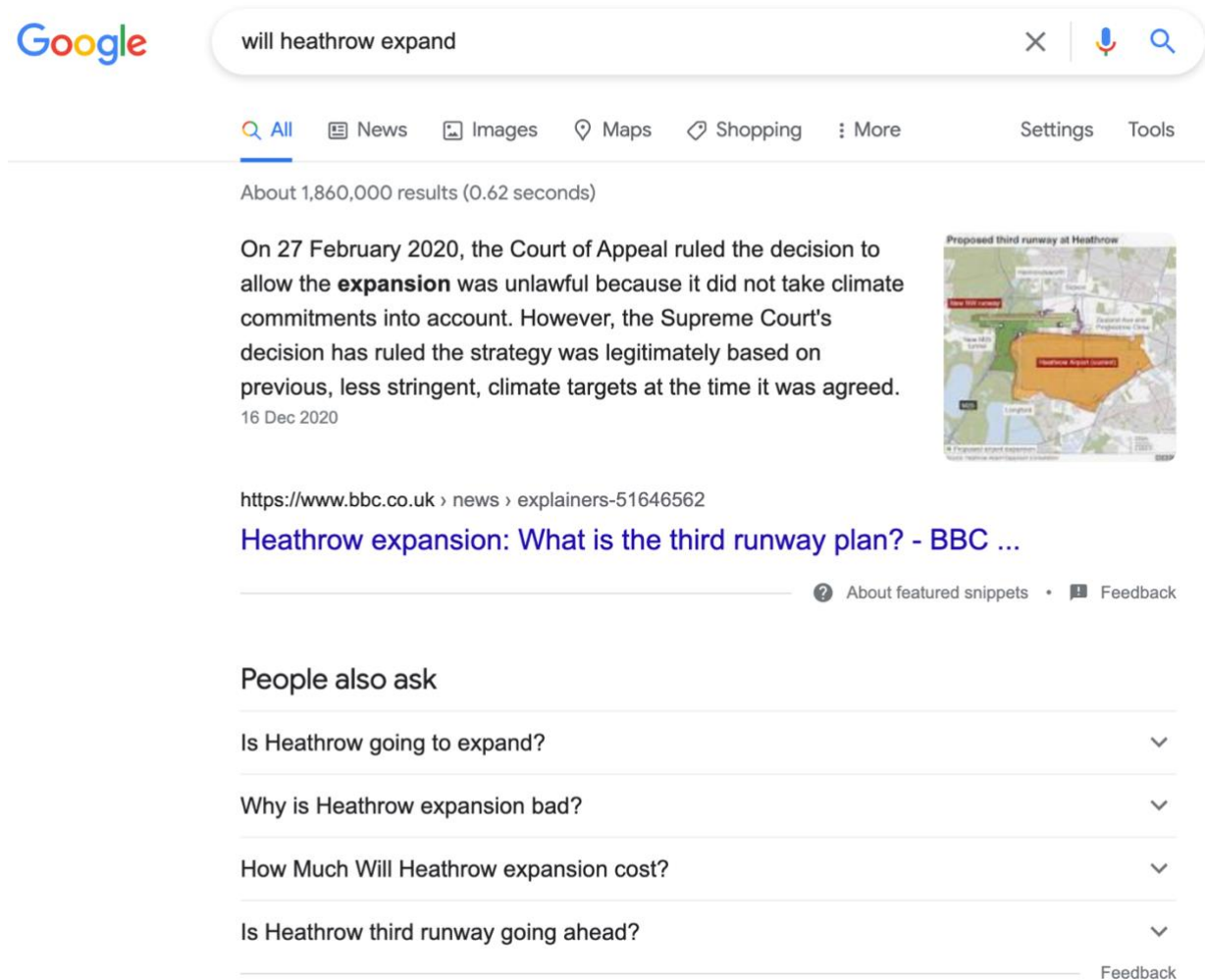

Figure 28: An example of a featured snippet on Google

'People also ask' are questions Google has found to be extensions of the main search performed based on data relating to the original search.

The main points to keep in mind when attempting to get featured in either the featured snippet or 'people also ask' positions is to create content that addresses a user's pain point or need, and to structure the content in a way that is rewarded by Google.

This could be a paragraph focused around a specific section of a topic, a list of things or a table of items with descriptions or assets.

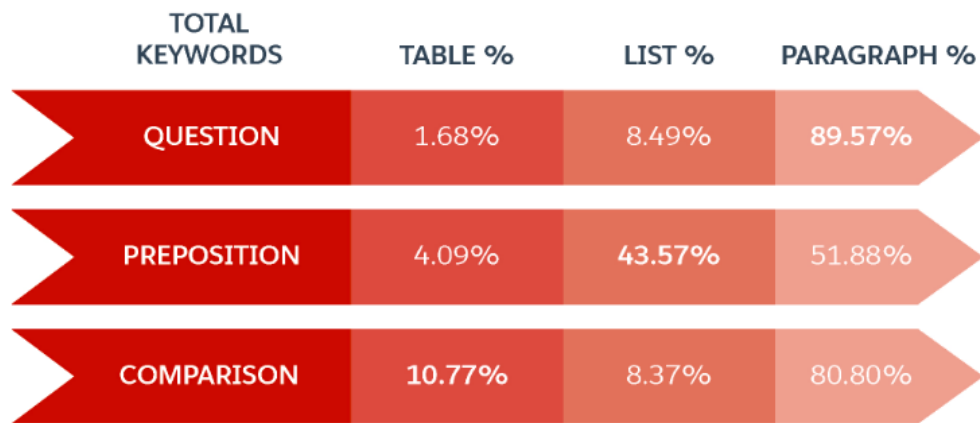

Figure 29: The different types of featured snippets possible, based on their occurrence in the Semrush study²⁷

SEMrush, in partnership with SEO content marketing company Ghergich & Co., analysed 80 million keywords to see how Google determined featured snippets. Of the results analysed, certain patterns emerged which are shown in the image below.

The full research with details on how to best structure content in tables, paragraphs, and lists, please refer to the detailed post 'How to Optimise for Google Featured Snippets [Research]'.²⁸

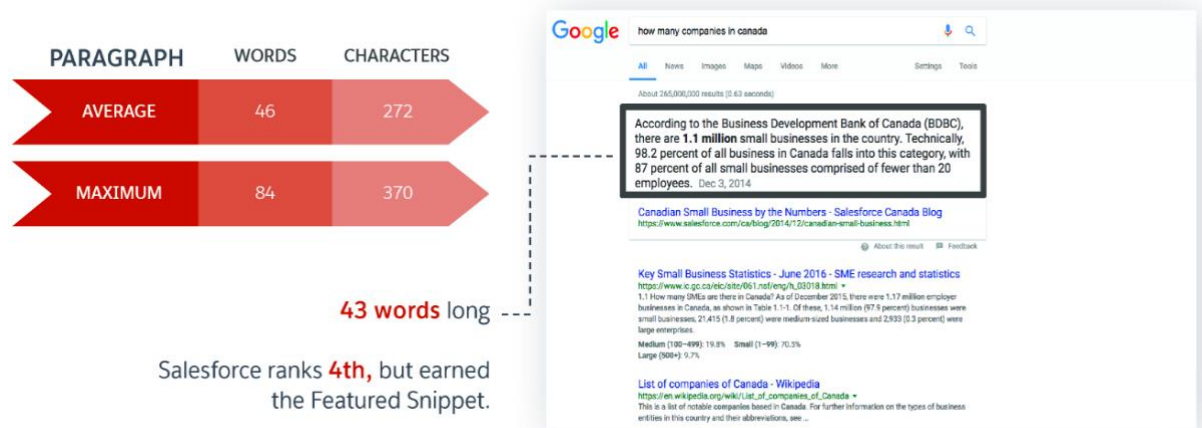

Figure 30: Example of paragraph Featured Snippet in search result with average and the maximum number of words and characters²⁹

²⁷ Source: <https://www.semrush.com/>

²⁸ Source: <https://www.semrush.com/blog/featured-snippet/>

²⁹ Source: <https://www.semrush.com/blog/featured-snippet/>

Link Building for PRs

7.1 Introduction

Gary Illyes, webmaster trends analyst at Google, said that: "Ranking without links is really, really hard. Not impossible. But very hard."

One of the important things a PR can do for their clients is to do their best to ensure that any online coverage includes links.

Links are one of the most significant ranking factors SEOs are aware of for Google and other search engines. The exact weighting and factors used to determine the quality of links are closely guarded secrets. Although the industry is aware of some factors, they are only a part of the whole picture only Google has.



Replying to @CarrieRosePR @bill_slawski and @louisevparker

I love some of the things I see from digital pr, it's a shame it often gets bucketed with the spammy kind of link building. It's just as critical as tech SEO, probably more so in many cases.

1:11 PM · Jan 23, 2021 · Twitter Web App

Figure 31: Google's John Mueller highlights the importance of digital pr over 'spammy' link building³⁰

7.2 Which sites provide valuable links?

To Google, it does not matter if a website is a blog or a media outlet with experienced journalists, when evaluating the amount of value that is passed through a link.

If the website is perceived as an authoritative site that can be trusted and/or has an expert voice, a link from that site is likely to be valuable.

³⁰ Source: <https://twitter.com/JohnMu/status/1352967238442229762?s=20>

Coverage which includes a link helps with SEO because the liked site is effectively getting an endorsement, which can have a positive impact via the influence the site has over its online audience as well as the influence it has within Google's view of the web.

If an individual trusts a writer and sees a link in their article to another website, they are more likely to trust that link in the same way as Google. Seeing a link on a trusted site, increases the perceived trust of the site that receives the link.

SHARE

Advertising

Q1 2021:

UK ad market expected to be the second highest for growth in 2021

Ad spend in the UK could grow at the second highest rate of all global markets in 2021, [Dentsu's Ad Spend Report 2021](#) predicts. Dentsu expects a healthy recovery for the UK ad market, forecasting a 10.4% year-on-year growth by the end of 2021, with only one other region – India – in front at +10.8%. France, Canada and Italy will also experience healthy growth at 8.9%, 7.2% and 5.9% respectively.

COMMENTS

While the US will continue to dominate the total share of global ad spend (37.9%), the UK ranks fourth in this area with a modest 5.1% share, also behind China (17.6%) and Japan (9.9%).

Understanding and predicting which new consumer behaviours will be temporary, and which will be permanent, will be the largest challenge for advertisers in the coming year. However, brands appear to be confident that social, search and video will be the biggest drivers of digital growth in the sector, despite the global outlook remaining uncertain in the first six months.

Top ad agencies make modest predictions for growth of global ad market in 2021

Recommended

NEW QUARTERLY BRIEFING

The new multichannel: Post-lockdown trends in marketing and ecommerce

18 MAY, 3PM BST | 10AM EST

Register now

BLOG SOCIAL

How Glossier sets the bar for social proof in ecommerce

WEBINAR DIGITAL STRATEGY

Digital Shift Q2 2020 Webinar

Figure 32: A good example of a coverage generated link to a high-quality report in a high authority website Econsultancy.com³¹

7.3 What is a link worth?

It is important to be aware of how Google sees links.

A single link on a webpage is evaluated against a large number of factors. The 'reasonable surfer' model³² seems to model that links higher up on the webpage may transfer more ranking value than those lower down.

This means that the position of a link and the likelihood of that link being clicked are now a part of the evaluation of the value of that link.

The image below from Google is used to explain how links pass value generally.

The value a page has to give to another comes from seed pages. This value diminishes over the number of hops from a seed page. Each page has a value it can pass through a link though there is no way of knowing how much value a webpage has to give through a link.

³¹ Source: <https://econsultancy.com/>

³² Source: <https://www.seobythesea.com/2010/05/googles-reasonable-surfer-how-the-value-of-a-link-may-differ-based-upon-link-and-document-features-and-user-data/>

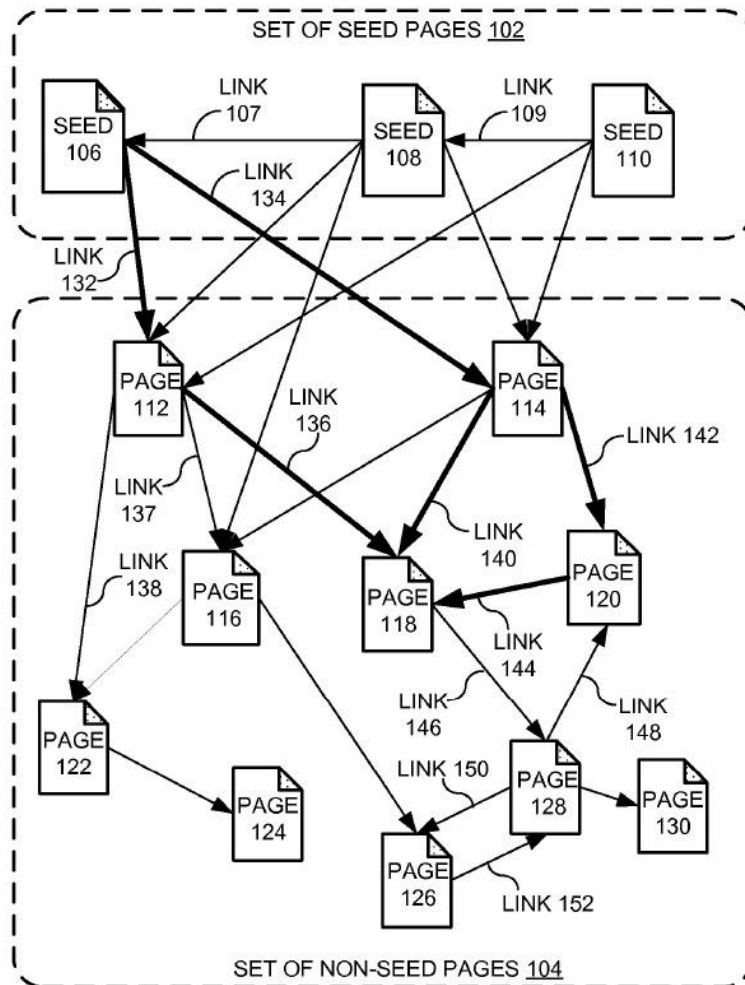

Figure 33: Evolution of the Link Graph weighting pages based on relevance factors from Google Patent US9953049B1³³

The value passed through a link can also be lost through division by the number of outbound links from the webpage.

One caveat to the model though is that a link from one webpage to a page with no topical relationship passes little to no value.

A link with a nofollow attribute also passes little to no value. When a nofollow attribute is added to the link, it looks like this: ``

7.4 What is a 'good link'

A good link should have the potential to refer relevant visitors to a webpage, rather than attempting to manipulate rankings.

³³ <https://patents.google.com/patent/US9953049B1/en?q=14%2f886%2c990%2bFiled:October%2b19%2c%2b2015>

It should be contained within the content, usually within the first two paragraphs is ideal. The link should be visible – that is, it should be clear and obvious to anyone visiting the page that there is a clickable link within the content. The link does not need to have any specific anchor text and is fine to just be a URL – it is the words around it that lend context for Google. The link is fine at the end of the article as well but this is less of a help for ranking.

7.5 Digital PR vs Link Building

One of the things that SEOs are currently doing is selling 'digital PR' work which is simply creative content generation with the intention of building links, something PRs have been doing for years but without the added emphasis on links.

By only pivoting slightly to include a focus on getting a link included within genuine coverage, and following up with journalists who don't include a link to try and get one included, PRs could outperform most SEO agencies and keep link acquisition safe (see 'Black Hat section' below).

7.6 What it takes to get links

In order to become the resource journalists or other writers link out to, the content created must be unique, as well as being well researched and professionally written.

To create content that is link-worthy will take time and effort and it is recommended that the piece is unique research or a piece of super-analysis - to demonstrate expertise.

For example, a report containing qualitative research and a model highlighting how internal communications and messaging has changed during the pandemic enabled technology company Guild to generate coverage and links through their outreach to journalists and bloggers.

A standalone piece of research or a study can also generate links if it is deemed relevant or newsworthy by journalists and bloggers.

RESEARCH SNAPSHOT

A hierarchy of messaging: What comes out on top?

In a report, in-person connections are the best option delivering sensitive news. Email is the least sensitive.

By **Ted Kitterman**
@tedkitkat
May 5, 2020



SHARE

[in](#) LinkedIn
[t](#) Twitter
[f](#) Facebook
[+](#) More

Different communications channels have different pros and cons.

According to a report from Guild, there is a hierarchy of workplace communications, but each type of communications meets a specific need. Even though email solutions might be imperfect, they offer important things like safety, compliance and confidence in security.

[FREE WEBINAR: [How to Write for Busy Readers and Keep them Engaged](#)]

Workflow options like Slack or Microsoft Teams offer productivity solutions baked in. Messaging apps like Yammer offer community, intimacy and self-expression.

See the full chart for how you can analyze if you are using the right tool for your message.

Figure 1: Hierarchy of Messaging Model



Image courtesy of Guild.

[Read the full report here.](#)

TOPICS: RESEARCH, RESEARCH SNAPSHOT, THE WORKPLACE

Hear from Top Wellness Experts

Ragan's Workplace Wellness Conference

Strategies and Tactics for Boosting Employee Well-being

Wednesday, April 21, 2021 • Virtual

Register Now

Ragan's Workplace Wellness Insider

Your employees' well-being is the bottom line.

Subscribe Now at the Special Rate

PR Daily News Feed

Sign up to receive the latest articles from PR Daily directly in your inbox.

Enter your email address >>

Today's Headlines I accept Terms of Use

RAGAN'S TOP WOMEN IN WELLNESS AND HR AWARDS

Honoring leadership in human resources and workplace wellness

Nominate the women who inspire you—or nominate yourself.

DEADLINE: MAY 14, 2021

Figure 34: A good example of coverage with a link from a high-quality report and model from messaging app Guild³⁴

³⁴ Source: <https://www.prdaily.com/a-hierarchy-of-messaging-what-comes-out-on-top/>

WhatsApp is the world's most popular messaging app – and usage has spiked during Covid-19 lockdowns. A study by market researchers Kantar found that WhatsApp usage grew by 40% globally in the first lockdown.

This popularity has inevitably leaked into work usage. A study by Guild, a rival app designed for professional use, claims that 41% of UK workers admit to using WhatsApp for work purposes, rising to 53% for workers who are under 45. This makes WhatsApp's privacy policy, which drew fresh scrutiny following a routine update earlier this year, a concern for employers.

The update itself was relatively innocuous but the roll-out prompted an outcry among customers, some of whom mistakenly believed WhatsApp was planning to share unencrypted messages from its parent (the company has firmly denied this). This outcry drew attention to the company's current privacy policy, which was updated in 2016, and sparked legal challenges from data protection agencies in India, Italy and Ireland.

Figure 35: Guild also generated coverage and links through research into WhatsApp use for work purposes³⁵

7.7 What writers cover and why they link

There are many other reasons journalists and content creators will link to content.

Addressing a common problem or opportunity in a unique or different way can attract links. If the company's expertise can deliver a solution, be it in the form of a calculator/tool/model, a video, or content, it will attract attention and hopefully links.

Being first to publish content that solves a problem will often result in links as others who later write about the same issue look for content to link to. It may be tied to offering a new way to do or approach something, but it could simply be bringing something first to market.

Researching keywords searchers are using but few are writing about is one way to generate new, needed content.

But the most important factor is identifying and targeting relevant journalists and content creators who actually care about and write about the topic that you are developing content, resources, reports etc around.

Equally important is how you approach and engage with them. Blanket spamming journalists with no interest in the topic should never happen and will doom you to failure.

Targeting the right journalist with the right content is the first step to getting coverage for your campaigns and clients.

That's why the Vuelio Media Database³⁶ is a critical tool. It gives you access to more than one million influencers, outlets and opportunities to connect you with the people that matter.

³⁵ Source: <https://techmonitor.ai/boardroom/whatsapp-privacy-policy-legal-headaches-for-employers>

³⁶ <https://www.vuelio.com/uk/pr-software/media-database/>

Broadcasters or journalists, expert bloggers or content creators - you'll find all the other information you need, from contact name and details to pitching preferences, favourite subjects, interests and dislikes. Unlike many PR databases, it's not scraped and has up-to-date information about writers, the topics they cover and other helpful information to enable you to reach the right person and tailor your pitch.

The screenshot displays a contact profile for Mr Ross Lydall. At the top, there are action buttons: 'Send vCard', 'Send Contact Update', 'Print', '+ To group', '+ Enquiry', '+ Interaction', and 'Notes (0)'. A dropdown menu shows 'N/A'. On the right, there are 'Forget', 'Edit', and 'Close' buttons. Below the name, there are three red tags: 'Health & Medicine', 'Health Service', and 'News & Current Affairs'. The main content area has tabs for 'MAIN', 'ATTACHED RECORDS', and 'AUDIT LOG PRIVATE CHANGES'. The 'Profile' section includes a bio: 'Covers Sadiq Khan and The London Assembly as well as overseeing health news.' and a 'Biography' section detailing his role at Evening Standard. The 'Contact details' section lists a website and email address. On the right, a 'Rating' section shows a score of 78 from MOZ, and an 'Outlet' section shows the Evening Standard logo and address: 'Northcliffe House, 2 Derry Street, London'.

Figure 36: Vuelio's media database provides up to date contact details and preferences of >1million journalists and content creators - and essential tool for successful coverage generation and linkbuilding ³⁷

And how do you know what you're sending is useful for the journalist, is in the right format and makes you a welcome name in their inbox?

That's where this complementary guide can help: ['How to Pitch to Journalists' guide.](#)³⁸

It provides helpful tips, general advice and definite dos and don'ts to bear in mind.

It covers pitching to news, features and editorial desks writing about current affairs, health, finance, travel, beauty and grooming, food and drink, fashion and more and contains advice from more than 40 journalists working over a wide range of media.

Another tool that helps with relevance and understanding what journalists write and care about is Vuelio's sister platform ResponseSource. Its long established and extremely successful Journalist Enquiry Service connects journalists to PR and communications professionals. Through it >30,000 journalists and broadcasters from national, consumer and trade media send requests to secure insight, information, stories from PR and comms contacts. The subscription service allows for a direct response to journalists' requests to help secure coverage. It an essential part of a modern PR and communications professionals' PR Tech Stack.

³⁷ Source: <https://www.vuelio.com/uk/pr-software/>

³⁸ Source: <https://www.vuelio.com/uk/resources/white-papers/how-to-pitch-journalists/>

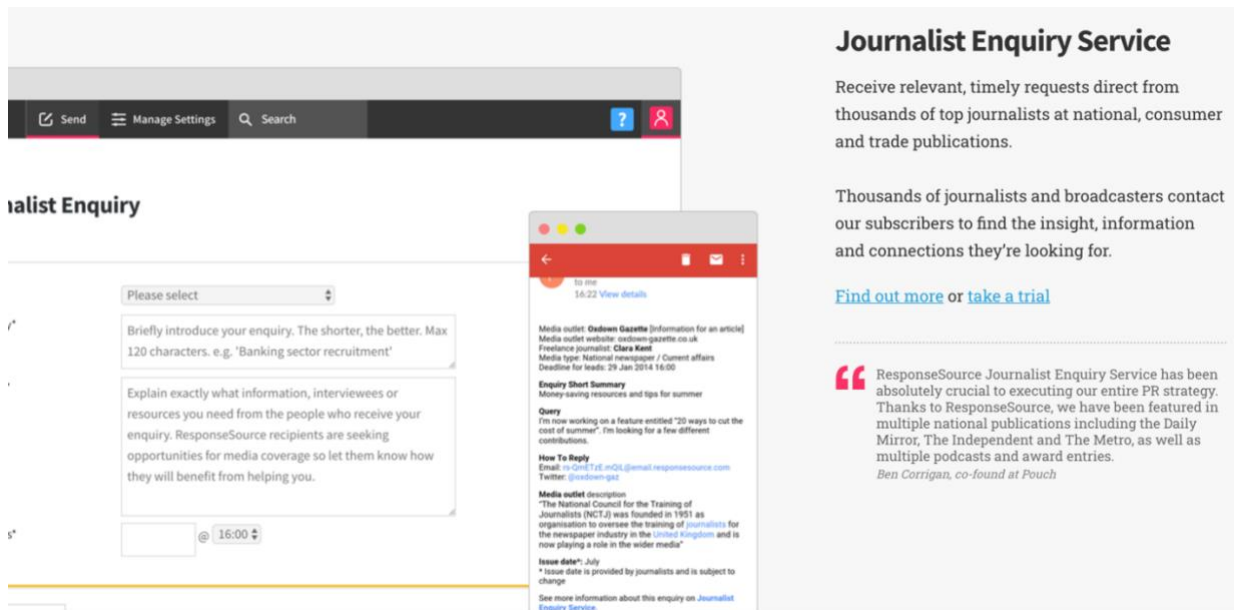

Journalist Enquiry Service

Receive relevant, timely requests direct from thousands of top journalists at national, consumer and trade publications.

Thousands of journalists and broadcasters contact our subscribers to find the insight, information and connections they're looking for.

[Find out more](#) or [take a trial](#)

“ ResponseSource Journalist Enquiry Service has been absolutely crucial to executing our entire PR strategy. Thanks to ResponseSource, we have been featured in multiple national publications including the Daily Mirror, The Independent and The Metro, as well as multiple podcasts and award entries. *Ben Corrigan, co-founder at Pouch* ”

Figure 37: ResponseSource’s Journalist Enquiry Service is an essential part of modern PR professionals’ PR Techstack and connects journalists requests to subscribers helping them secure coverage³⁹

7.8 Unlinked mentions

Content that results in news coverage can attract links - but not always. Some journalists don’t always give a link. For example, it’s unusual for the Daily Mail to link out to the originator of the content.

One way to help your company, or clients, is to research coverage gained and request a link, if relevant.

Vuelio’s media database also makes it easier to find the details of journalists and content creators who have covered a story or written about your topic, report, research, tool, but not given a link.

Converting unlinked mentions will result in improved backlinks and possibly increased rankings.

³⁹ Source: <https://www.responsesource.com/pr/journalistenquiry/>

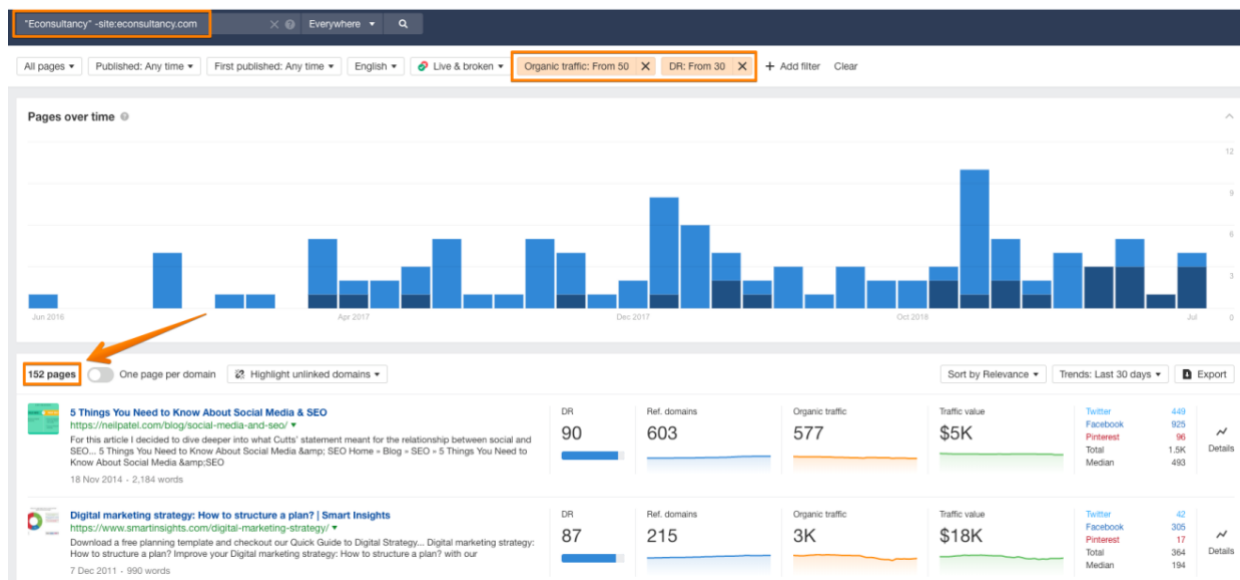

Figure 38: Finding unlinked mentions with Ahrefs⁴⁰

Unlinked mentions, also called citations, can be valuable as it helps contextualise what a site or person is associated with as long as Google can understand the context of the words around the name of the individual or business.

Content that has a higher potential to result in coverage is also examined by Jonah Berger, Professor of Marketing at Wharton Pennsylvania, in the opening chapter of his book 'Contagious'. The book examines what it is that makes something 'shareworthy'.

7.9 Social media and links

It should be noted that social media links do not impact in any direct way whatsoever on the ranking of content.

Increased levels of social sharing that correlate with increased rankings, is often related to signals from social media that the content has gained attention elsewhere, and is therefore being written about in a variety of places.

Social media posts on Twitter do not influence ranking.

This does not mean social media is not valuable, but rather that social media has a lower SEO value – even if it has a higher brand awareness value.

⁴⁰ Source: <https://ahrefs.com/>

7.10 Chasing competitor links

Having done a competitor link analysis as described previously, another opportunity is to examine what content competitors created and attempt to replicate their success around a similar but different topic.

So, if a competitor has written a content piece about the top 25 beauty bloggers in the UK, a different approach could be to write an article about the 125 top beauty bloggers around the world, then use the places who linked to the 25 beauty bloggers article as a starting place to seek coverage.

After all, if a paper or blog linked to a previous iteration of the article, it means they are probably open to linking to an updated version, or a more expansive one.

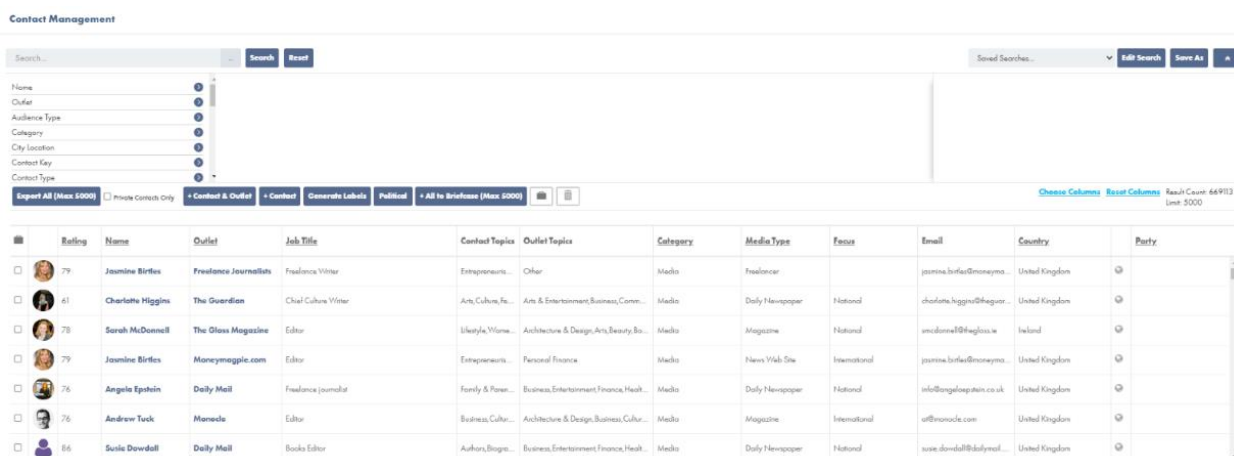

The screenshot displays the 'Contact Management' interface of Vuelio. It features a search bar at the top with 'Search' and 'Reset' buttons. Below the search bar is a sidebar with filters for Name, Outlet, Audience Type, Category, City Location, Contact Key, and Contact Type. The main area shows a table of contacts with columns for Rating, Name, Outlet, Job Title, Contact Topics, Outlet Topics, Category, Media Type, Focus, Email, Country, and Party. The table lists several contacts, including Joanne Birles, Charlotte Higgins, Sarah McDonnell, Joanne Birles, Angela Epstein, Andrew Turk, and Susie Dowdall.

Rating	Name	Outlet	Job Title	Contact Topics	Outlet Topics	Category	Media Type	Focus	Email	Country	Party
79	Joanne Birles	Freelance Journalist	Freelance Writer	Entrepreneurs...	Other	Media	Freelance		joanne.birles@money...	United Kingdom	
61	Charlotte Higgins	The Guardian	Chief Culture Writer	Arts, Culture, Fi...	Arts & Entertainment, Business, Comm...	Media	Daily Newspaper	National	charlotte.higgins@the-guardian.com	United Kingdom	
78	Sarah McDonnell	The Glass Magazine	Editor	Lifestyle, Women...	Architecture & Design, Arts, Beauty, Ba...	Media	Magazine	National	smcdonnell@glassmag.com	Ireland	
79	Joanne Birles	MoneyMaggie.com	Editor	Entrepreneurs...	Personal Finance	Media	News Web Site	International	joanne.birles@money...	United Kingdom	
76	Angela Epstein	Daily Mail	Freelance Journalist	Family & Power...	Business, Entertainment, Finance, Health...	Media	Daily Newspaper	National	info@angelaeppstein.co.uk	United Kingdom	
76	Andrew Turk	Moneys	Editor	Business, Culture...	Architecture & Design, Business, Culture...	Media	Magazine	International	at@monies.com	United Kingdom	
66	Susie Dowdall	Daily Mail	Books Editor	Authors, Design...	Business, Entertainment, Finance, Health...	Media	Daily Newspaper	National	susie.dowdall@daily-mail.com	United Kingdom	

Figure 39: Vuelio's media database contact search screen can help identify journalists and bloggers who have covered competitor stories or other stories similar to the one you are pitching⁴¹

7.11 Outreach

Outreach is the more common method of engaging with journalists and creators who publish specifically online in order to create relationships and achieve coverage.

There are a number of methods and tools to help identify suitable media, bloggers and creators however Vuelio has an extensive database, making the job of identifying outreach targets easier.

It is worth stating at this point that this is not a comprehensive resource for teaching PR and comms professionals how to engage with journalists, but a summary overview of how to approach outreach with a focus on positive SEO outcomes.

⁴¹ Source: <https://www.vuelio.com/uk/pr-software/media-database/>

7.12 Planning Outreach – Topic Identification

There are tools that can layer even more insights for outreach for Comms and PR professionals. For example, Pulsar, the advanced audience intelligence and social listening software, is Vuelio's sister platform.

Users of Pulsar can research topics, and keywords within those topics, which can then further be used to identify the audiences related to those topics. It can deliver deep insights around which themes are generating the most conversations/discussions and which online media and individuals are influential around those topics.

These topics can cover anything that is being discussed or written about online and in social media, from personal finance, technology, travel, music or food, right down to sub-topics such as veganism and vegan recipes.

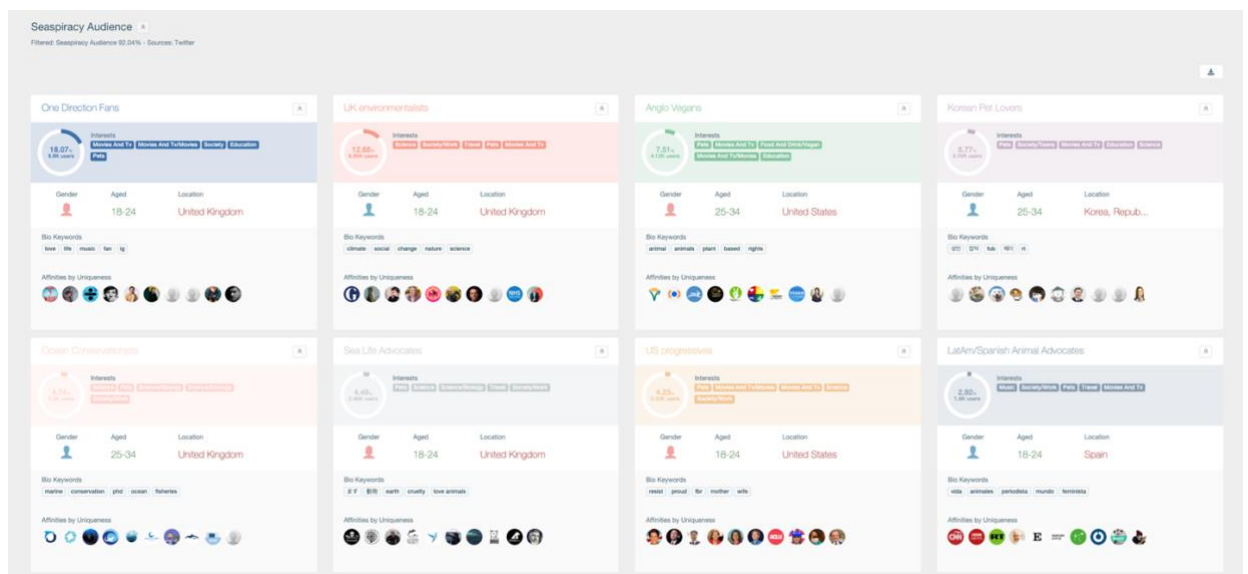

Figure 40: Pulsar helps PR and comms professionals understand any topic or conversation, get a snapshot of the audience segments behind that conversation and identify each segment's top influencers and affinities. This helps plan campaigns with maximum audience resonance⁴²

Understanding a topic in depth and identifying what creates debate, discussion or might even be bubbling under as a potential theme or topic can be used to create content or research for outreach. This is where Pulsar (amongst many other uses, such as campaign measurement, social media listening and influencer identification) can be utilised to great effect.

Pulsar accesses a wide range of online and social media sources, including TikTok, Pinterest, Reddit, Instagram, News, Twitter and other online data sources. It can identify the sub-topics and influential communities and voices within those topics and subtopics, as well as the show the visual and text-based language being used to describe specific topics or issues.

⁴² Source: <https://www.pulsarplatform.com>

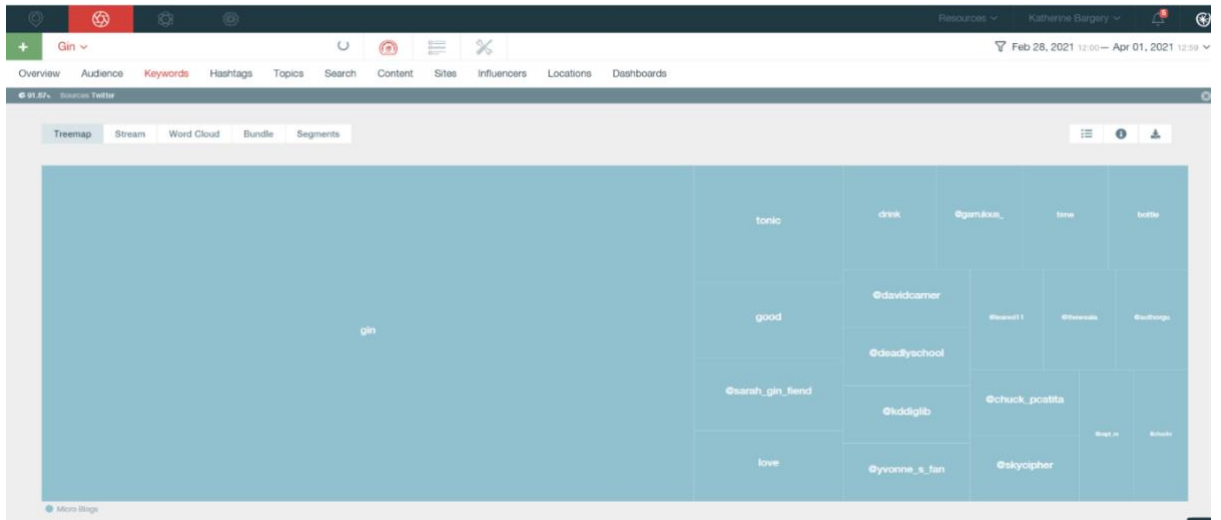

Figure 41: Image from Pulsar of keywords being used within social media conversation about Gin⁴³

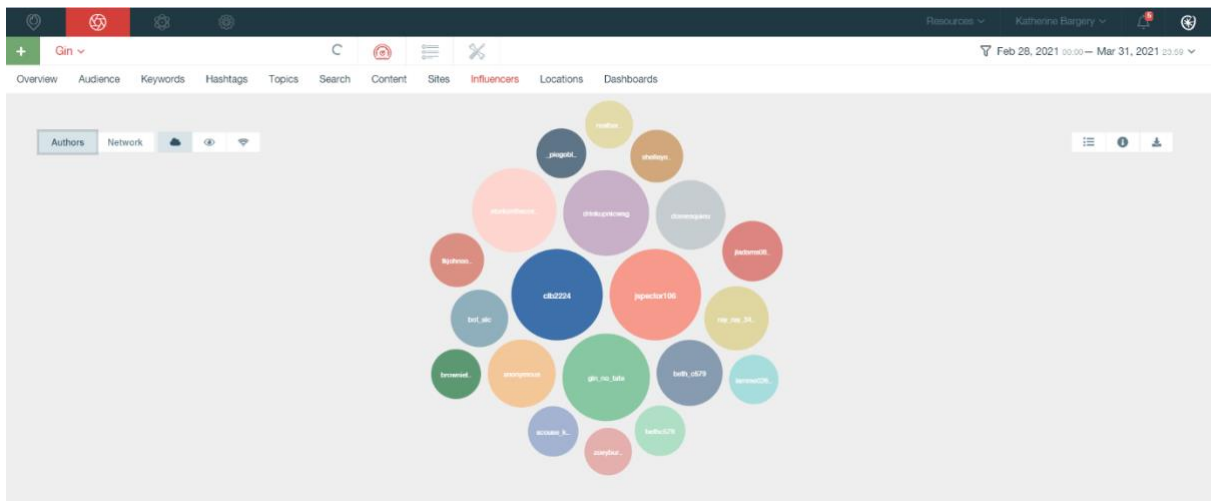

Figure 42: Visual representation of the top influencers within the conversation around gin to help with outreach target selection and deep topic knowledge⁴⁴

Vuelio and Pulsar are tools that make the arduous process of identifying relevant media and journalists and the right topics for the right media and influencers much easier - ensuring outreach time and effort is expended in the right areas.

Media usually have a preference for original research which can also be conducted via Pulsar.

For example, this highly visual Covid public and healthcare professional vaccine sentiment tracking study on the Pulsar website was created using Pulsar tools and has been used by media outlets to highlight public opinion.

⁴³ Source: <https://www.pulsarplatform.com>

⁴⁴ Source: <https://www.pulsarplatform.com>

Public enthusiasm towards a vaccine soars with news of single-shot efficacy
 Political, clinical and supply issues drive the greatest swings in sentiment around each vaccine

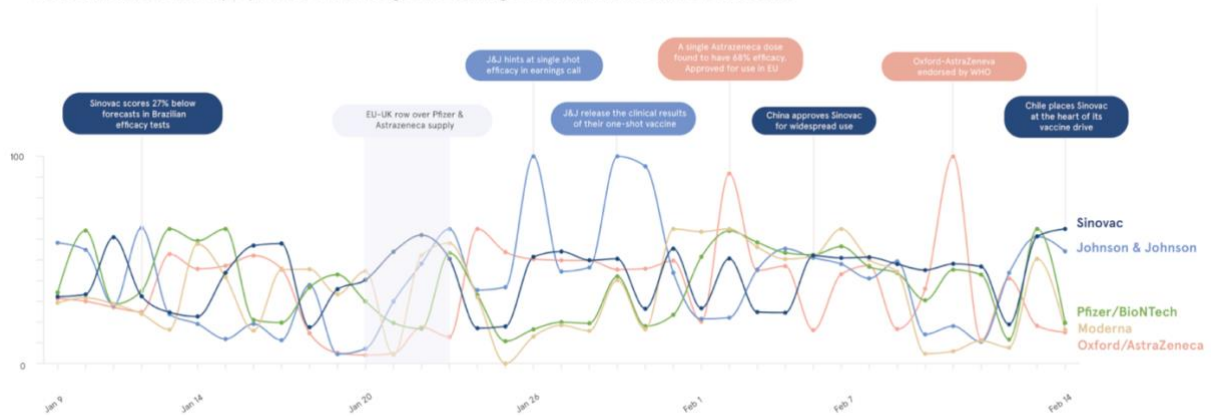

Global sentiment towards the most mentioned vaccines across Twitter, YouTube, Sermo, Forums, Blogs, Reddit and other social, news and review sites, Jan 11 - Feb 14 2021.
 Source: Pulsar TRAC.

Figure 43: Creating high value and original research using Pulsar, like this Covid vaccine public and healthcare professional sentiment tracking study is one way to gain coverage and links⁴⁵

YouGov research is seen as the best way to do research by some, but YouGov can be difficult to navigate and has, in the author's experience, been oversold with regards to available audience types.

Others in digital PR report that the YouGov brand is so strong, the actual commissioner of the research is sometimes being ignored. For single question research Censuswide is a valuable resource and can handle multiple selections.

Some organisations, such as Charity Aid Foundation have their own research function generating regular high quality qualitative and quantitative research for the Charity and Not-for-profit sector. This approach not only helps them generate visibility and links in media but allows them to position themselves as thought leaders in their sector.

⁴⁵ Source: <https://www.pulsarplatform.com/blog/2021/the-covid-vaccine-sentiment-index-tracking-public-attitudes-toward-each-vaccine/>

About 6,000,000 results (0.63 seconds)

Scholarly articles for **influence of pandemic on charitable giving**

... protect firm value during the COVID-19 **pandemic**? - Qiu - Cited by 8

Field study of **charitable giving** reveals that reciprocity ... - Chuan - Cited by 12

<https://www.cafonline.org> › About CAF › Research ▾

The coronavirus outbreak and charitable giving | CAF Research

International **impact** — New measures to support the high street, announced in the 2021 budget, will positively **impact** around 1 in 5 smaller **charities**.

<https://www.cafonline.org> › About CAF › Global Alliance ▾

How COVID-19 is affecting charities globally | CAF Global ...

Find out how **charities** and donors are reacting to the covid-19 **pandemic**. ... CAF: **Charities Aid Foundation** ... This research can contribute to global discussion about the **impact** of the **pandemic** on the third sector and what policy and support is ...

Figure 44: Example of a search looking for research-led pieces highlights Charity Aid Foundation’s high-quality research

7.13 Doing Outreach

Once relevant journalists and influencers for outreach to have been identified in Vuelio and Pulsar and you have created your campaign content, research or tool, using the Vuelio platform for the actual outreach is invaluable.

Vuelio is the best way to find, segment, and record outreach work. Vuelio can also be used to track relationships longer-term, across your team and ensure they become part of your regular contacts.

Leveraging all possible avenues to reach out to influencers to demonstrate expertise and relevance is a great way to build links.

7.14 Ideas for passive link building

Keyword research, referenced earlier, is an excellent way to find searcher intent but also it is an excellent way to find people looking for material to cite or use as references which could be created.

Find what journalists need to know – as mentioned before through Vuelio and ResponseSource’s Journalist Enquiry Service (JES) and give them what they are looking for.

With the JES approach, building something that meets the immediate need, but also building something larger from that immediate need (if there is keyword research-based demand) could also work as a way of building links. This method still requires unique research but could see JES-provided content be reused and continue to build links.

SEO consultant Stacey MacNaught has advanced the very successful idea of passive outreach through photographic image assets. She suggests specifically creating images which are in demand, reflective of society, visually work and as busy or simple as makes sense.

While the images are created for link building, by labelling with the correct Creative Commons⁴⁶ license, images can be used with attribution, as the images are found. This does mean uploading them to Flickr or similar, optimising the images, as well as designating them with the right CC attribute. When the image is used and correct attribution given, the site should gain links.

Simple, passive link building is more of a long-term strategy and does require a willingness to allow the images to be used. You can read more about Stacey's Image Link Building ideas here.⁴⁷

Of course, images don't solely have to be photographs, again Pulsar uses its own tools to create data and charts, such as this one highlighting which alternative milk brands and categories are the most talked about online.

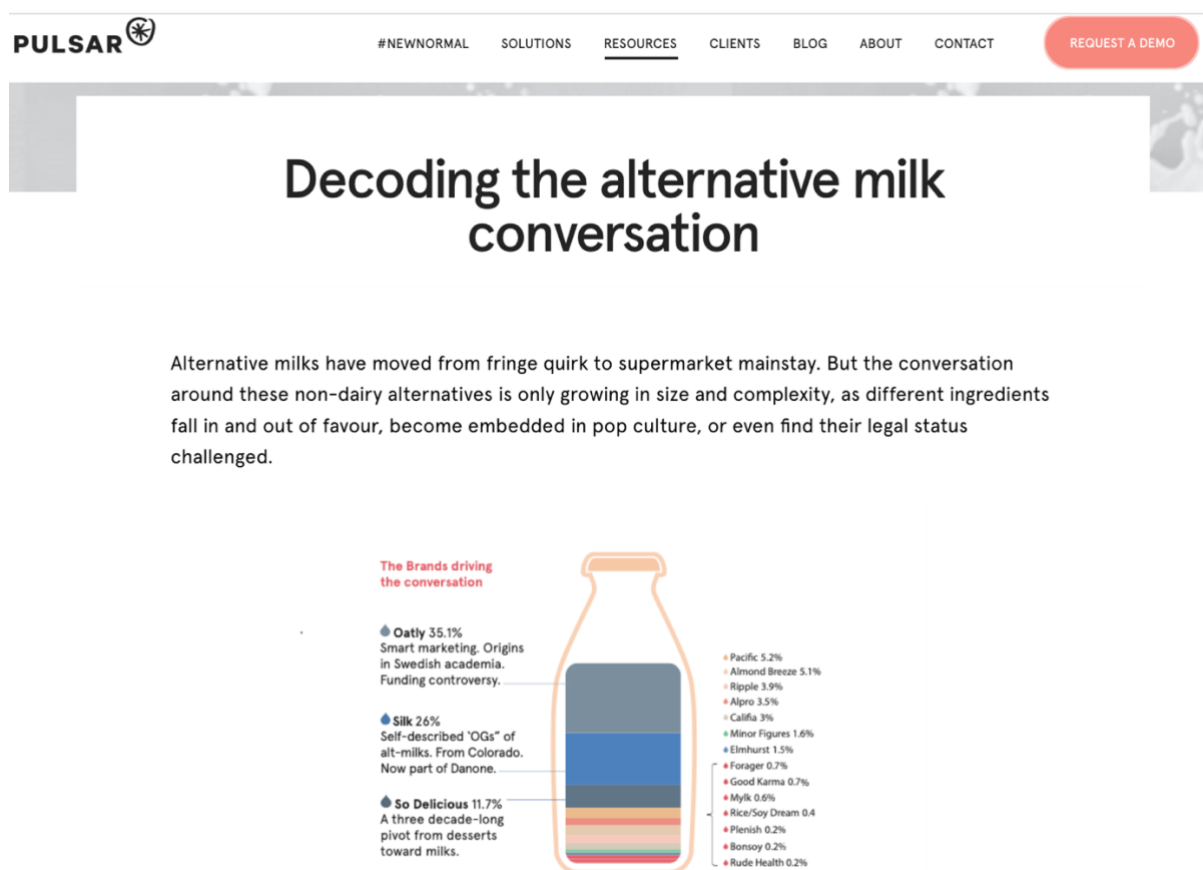

Figure 45: An example of an image that can attract passive links – Pulsar have used their own tool to track and chart which alternative milk brands are the most talked about online⁴⁸

⁴⁶ Source: <https://creativecommons.org/choose/>

⁴⁷ Source: <https://www.staceymacnaught.co.uk/image-link-building/>

⁴⁸ Source: <https://www.pulsarplatform.com/resources/decoding-the-alternative-milk-conversation/>

But what happens when someone uses your images and fails to attribute, or link?

This is usually by accident, but by using `reverse image search`⁴⁹ on Google, Bing or TinEye on any image you've created from charts for content, illustrations and even product photos, you can then ask the site using the image for attribution with a link.

⁴⁹ Source: <https://www.semrush.com/blog/reverse-image-search/>

Benchmarking and Measuring SEO Success

Reporting on success when measuring not just coverage but link acquisition need not present challenges.

Counting links acquired is a way to demonstrate success. Using third party tools such as Moz, Semrush, Ahrefs, or Majestic can also be helpful in measuring the number of links a site has before some activity is undertaken, and afterwards.

Third party tools do not update daily and sometimes do not often update so there can be some limitations when using them to measure, however they are useful to help augment the existing reporting that will already be done for clients.

Setting goals can help to monitor the success of any strategy. It is important, however, to allow some level of fluidity in goals – mistakes happen, projects are delayed, and search engines change the way they measure webpages.

Depending on the industry, there are a number of metrics that could and should be benchmarked. Some good metrics to measure could be:

Traffic sources – in order to see where traffic is originating from to better understand how content is performing, use traffic sources in any analytics package (though most will use Google).

This means not just looking at traffic from organic search, but also direct, because referrer data is often stripped from links, and referral traffic, all of which will be relevant to a PR or communications professional.

If all traffic from a specific source fails to convert or dwell or take any action, there may be an issue. See also: <https://support.google.com/analytics/answer/6205762?hl=en>

Keyword rankings – a popular metric. There are several tools that will give a business insight in to where competitors are ranking for certain keywords, as well as being able to extract what keywords a competing business is ranking for, and track how a business is performing against those keywords. Among the wide array of tools available are Google Search Console (no competitor data), SEOmonitor <https://www.seomonitor.com/> , Semrush <https://www.semrush.com/> , and Ahrefs <https://ahrefs.com/> , plus free tools such as Rank Tracker <https://www accuranker.com/rank-tracker> and Mobile SERP Test <https://mobilemoxie.com/tools/mobile-serp-test/>

Click Through Rate - measured in Google Search Console only, this is an indication of how well content is performing for each individual keyword, as well as each individual page. Google does provide a whole-site overview, but this is only useful as a broad quick check as each page and each keyword will have different CTRs and rankings. For more on this measure in Google Search Console, see: <https://support.google.com/webmasters/answer/7576553>

Dwell time – bounce rate is not a valid metric. Bounce rate is sometimes used to understand why content seems to convert less, which PRs and communications professionals will usually find outside their remit. To see how long people are spending on each page, and on the site overall, dwell time can help measure engagement with content created.

This can help inform the content strategy through understanding which pages see longer dwell time and which pages have relatively short dwell times. This only works as long as those pages are not usually single-page landing pages (dwell time is not straightforward and must have changes made to a website in order to be recorded accurately - see <https://www.simoahava.com/analytics/measure-serp-bounce-time-with-gtm/>).

Site performance – speed is a ranking factor now. Benchmarking this against competitors using a tool such as Sandbox <https://tools.sandboxweb.io/site-speed-comparison-tool> is important to monitor and ensure the time keeps coming down. Directly influencing this metric is usually outside the remit of PR and communication professionals however when analysing why content might be underperforming it is good to know.

Measuring success can be slightly more difficult. Unless a very specific piece of work was undertaken to change keyword rankings, it can be difficult to know what to report on.

It is recommended by some SEOs to check the number of keywords a site ranks for in Semrush before the work was undertaken (benchmark), compared to after. When building content, this can be especially useful as the increase in the number of keywords ranking, as well as how well they are ranking, can then be attributed to the work undertaken.

For link building, third party tools take longer to include new links in their indices and so are less useful for reporting but if the project lasts several months, these tools could help show the site benchmark against the progress over the months.

One reporting template that may help add SEO metrics to your reporting can be found here: <https://ahrefs.com/blog/seo-report-template/>

Another key success metric for some businesses will be the measurable impact of which links directly drive conversions. For example, if a link to a specific page from coverage generated can be measured in terms of an action that has value.

In the case below from the messaging app Guild it could be newsletter or specific group sign ups, e.g. The Charity Marketing Digital Comms Pioneers Group or even a business subscription to the app.

Measuring the impact on conversions will need to be done at the website analytics level. And that's the subject of a whole new report and guide!

Friedlein's Guild Teaches the Industry How To Leverage B2B Communities

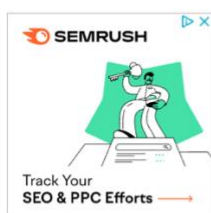

Ashley Friedlein's Guild, the messaging platform for professional groups and networks, has launched a new guide on Community Based Marketing and its strategic role in B2B marketing today.



GIVING TUESDAY

I'm a charity

I'm an individual

I'm a business

Be a partner

Guild's #GivingTuesday gift to charities

All charities need to be able to communicate quickly and effectively to their supporters, donors, staff, volunteers, members, trustees and beneficiaries. And they also need to do it in a way that is safe, GDPR compliant and simple.

Guild is a 'tech for good' messaging and community building platform.

They are offering to support charities in these tough times with a wonderful Giving Tuesday 2020 free gift.

Guild is partnering with us and registered charities in the UK giving them the chance to sign up and use their ad-free, professional messaging app for FREE, for life. (Terms and Conditions apply – see below).

How can Guild help your charity?

Figure 46: Measuring conversions from backlinks can include newsletter sign ups, or in this case from these examples of coverage from Guild, business/charity subscription enquiries and even Guild group membership requests⁵⁰

⁵⁰ Source: <https://www.brandchiefmag.com/> and <https://www.givingtuesday.org.uk/>

SEO and ethics

The Public Relations profession is supported by associations such as Chartered Institute of Public Relations (CIPR) and the Public Relations and Communications Association (PRCA), where members must uphold professional standards and follow a code of conduct.

Search Marketing doesn't have a direct equivalent.

As a relatively new discipline, there have been examples over the years of dubious practices in SEO. Of course, one could argue that Google is the organisation that provides the 'code of conduct' by changing its algorithm to adapt to 'spammy' or irregular practices designed to secure links.

9.1 What is 'Black Hat' SEO?

This is a term used by the SEO industry to describe the deliberate manipulation of search engine indexes involving a number of methods, such as link building through purchasing links, over-optimising every possible element of a page, and similar.

Few relate hacking and other criminal activities to black hat SEO and yet it should be. Any criminal activity is considered Black Hat and more recently, any activities that violate Google Webmaster guidelines found here: <https://developers.google.com/search/docs/advanced/guidelines/webmaster-guidelines> are considered to be Black Hat.

These guidelines are extensive and do relate to activities outside what would be the normal remit of PR and communications professionals, however it is important to be aware of them in order to ensure all people engaged in increasing the visibility of a website are on the right side of the guidelines.

The reality is that link building is Grey Hat SEO as it is often done to manipulate search rankings which is against Google's guidelines. This does bring up the question as to whether outreach for the purpose of links and coverage created purely for the purpose of link building is against Google's guidelines and therefore black/grey hat.

Google's John Mueller has stated on Twitter that Digital PR (often perceived to be where a company's profile is being elevated and the coverage gained happens to include a link) is as critical as Technical SEO.⁵¹ Technical SEO can be the difference between a website ranking well or not at all so this is a significant statement by a Google representative.

Google's guidelines about link schemes are here: <https://developers.google.com/search/docs/advanced/guidelines/link-schemes>.

Any work where the only goal is links is still artificial link building as per Google's guidance on Link Schemes which includes for example, sending someone a "free" product in exchange for them writing it and including a link. The job of PR and communication professionals is often to increase the visibility of their 'client' (be that their employer as they sit in-house, or the client of the agency they are working for) and including links back to the 'client' is simply ensuring the work delivered to get people aware of the brand results in a visit, and perhaps sales.

⁵¹ Source: <https://twitter.com/JohnMu/status/1352967238442229762?s=20>

From an SEO perspective (there are other rules and legal considerations covering influencer marketing, for example ASAs CAP Code) the key is that the product being sent for review is not for the link but for the review. Not requiring the link as part of the provision of the product is essential.

Obviously, the work of gaining visibility is important for any company. Links are critical for ranking well. It is inadvisable to undertake any activity where the only desired outcome is a link, however this is generally not how most PR and communication professionals work within their profession and so is unlikely to be an issue.

Reading, Resources, and Continued Education

SEO is a vast topic. It is one that evolves as search engines, online media and user behaviours change.

We hope that this guide has provided you with helpful tips and guidance aligned to your sector and profession.

Here are some selected resources if you wish to continue your exploration of the topic.

[SERroundtable](#) – for news and information about search topics including changes that Google announces.

[Search Engine Land](#) – for news about the search industry.

[The Moz Blog](#) – the value the tool has waned, but the value of the blog remains strong.

[SEOFOMO](#) – a weekly newsletter by Aleyda Solis which rounds up the most important and impactful news of the week. A subset of the news is also covered in her weekly Clubhouse

[LearningSEO.io](#) – Aleyda Solis’ extensive learn-it-yourself SEO guide covering all possible introductory topics for learning SEO

Essential SEO tools

[Ahrefs](#) - a full suite of SEO tools including keyword research and backlink auditing. Also have a blog for information beyond what the tool can do.

[Semrush](#) – the most frequently used example in this guide, this tool is one of the most powerful for the price delivering keyword research, competitor audits for keywords and backlinks, content auditing, paid search research and more. Also have a very informative blog and training for free.

[keywordtool.io](#) – a freemium keyword research tool that has a free level to help with some limited keyword research.

[Google Search Console](#) – a free tool provided by Google which has to be validated against a site but once done, can be used for deep insight about that website. Only for owned websites – cannot be used for competitor auditing.

[Rank Tracker](#) – a free but limited tool for checking rankings

[Mobile SERP Test](#) – a free but limited tool for checking specifically the mobile search results for a query.

[SEOMonitor](#) – a rank tracking tool with additional technical auditing and monitoring capabilities

[Sandbox](#) – a tool for comparing the site speed of the sites for which it is available in the SERPs

[ResponseSource Journalist Enquiry Service](#)– quality journalist requests that enable you to build relationships with journalists and get media coverage
<https://www.responsesource.com/pr/journalistenquiry/>

[Vuelio](#) – the UK's largest database of journalists, editors, bloggers, social media contacts, national & local press. An essential PR & communications software tool that also includes distribution & monitoring, analysis and political and stakeholder data and many other features.
<https://www.vuelio.com/uk/>

[Pulsar](#) – advanced audience intelligence and social media social listening tool. Find audience and media insights and stories in the data. Identify topics, themes and influencers to power your campaigns and content.
<https://www.pulsarplatform.com/>

